



**DFM**  
INTERNATIONAL

**GROWTH  
STRENGTH  
EXCELLENCE**

**2025  
CATALOGUE**



**DFM**  
INTERNATIONAL

**GROWTH  
STRENGTH  
EXCELLENCE**

New Products

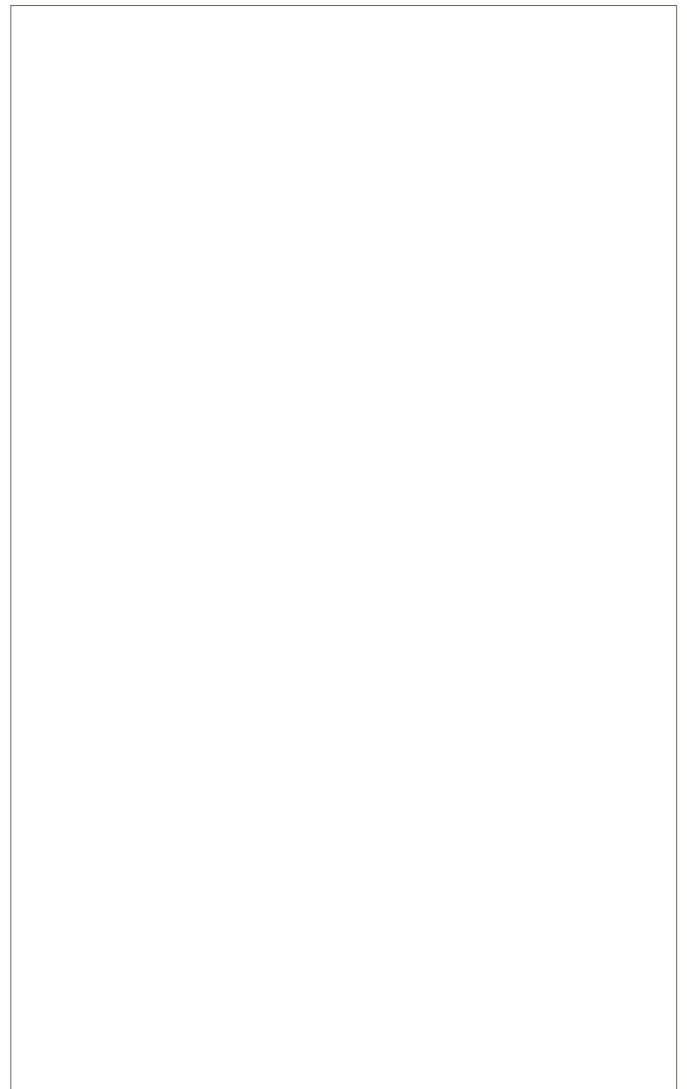



Item #	Size	Qty per cse
--------	------	-------------

Item #	Size	Qty per cse
--------	------	-------------

### Triade

### Spray Gun Extension

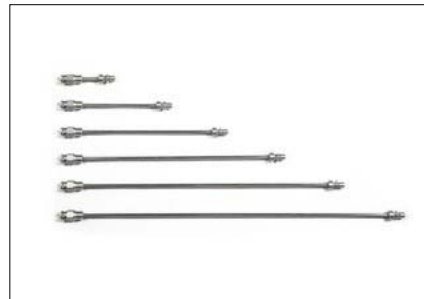

· Multiple size ·

TCR-06	6	1
TCR-12	12	1
TCR-18	18	1
TCR-24	24	1
TCR-30	30	1
TCR-36	36	1

### Triade

### O-Ring



· For spray gun extension ·

TCO-01		1
--------	--	---

### Triade

### Adapter



· For spray gun extension ·

TCAD-02		1
---------	--	---

### SolvEco

### Strong Stripper



· VOC compliant ·

CSTM-01	946 ml	12
CSTM-04	3,78 L	4
CSTM-20**	18.9 L	1

\*\*DANGEROUS GOODS TRANSPORTATION GRADE

- Professional
- Low odour
- From Super Remover manufacturer



Item #	Size	Qty per cse			Item #	Size	Qty per cse		
--------	------	-------------	--	--	--------	------	-------------	--	--

## OPGUARD C10

## Surface Preparation C10



· Surface Preparation ·

OPGC1000946	946 ML	11
OPGC1003780	3.78 L	4
OPGC 1018900	18.9 L	1

## OPGUARD C20

## Cleaner Degreasing C20



· Cleaner Degreasing ·

OPGC2000946	946 ml	11
OPGC2003780	3.78 L	4
OPGC2018900	18.9 L	1

## OPGUARD R10

## Paint Remover R10



· Paint Remover ·

OPGR1000946	946 ml	11
OPGR1003780	3.78 L	4
OPGR1018900	18.9 L	1

## GOTHAM

## Eco-Solv Paint Thinner



· VOC Compliant ·

117-1	946 ml	12
117-4	3,78 L	4

Replace products # 107-1 and 107-4

- With Mineral Spirit
- Professional Quality
- Low Odour





Item #	Size	Qty per cse	Item #	Size	Qty per cse
--------	------	-------------	--------	------	-------------

### Métallic

· 500 ml ·

PE700935	Silver 101	12
PE700936	Charcoal 124	12
PE700937	Moka 128	12
PE700938	Hot chocolat	12
PE700939	Copper 106	12
PE700940	Aqua 143	12
PE700941	Misty Blue 112	12
PE700942	Violet 116	12
PE700943	Olive 113	12

### Epoxy Colourants



### Universal

· 500 ml ·

PE700920	Super White 433	12
PE700921	Light Grey 885	12
PE700922	Medium Grey 663	12
PE700923	Shady Grey 305	12
PE700924	Silver 524	12
PE700925	Almond 431	12
PE700926	Dark Beige 999	12
PE700927	Black 459	12
PE700928	Pale Grey 306	12

### Old Masters



### Spar Varnish

· Oil based aerosol 369 g ·

C92310	Satin	6
C92410	Gloss	6
C925100	Semi-Gloss	6

### Pro Select



### Paper Hand towel

· Box of 12 rolls ·

2900333	350'	1
---------	------	---

### Garbage Bags



### Black Garbage Bags

· Box of 1000 Regular Bags ·

3385124	22" X 24"	1
---------	-----------	---

· Box of 125 Heavy Duty Bags ·

3392250	35" X 50"	1
---------	-----------	---



Item #	Size	Qty per cse	Item #	Size	Qty per cse
--------	------	-------------	--------	------	-------------

### Masking Liquid

### Clear Masking Liquid



· Clear ·

800-400-4	946 ml	6
800-400-1	3,78 L	4

- Water based

### Simms

### Golden Touch Brush



· Polyester Wall Brush ·

CS-1750-75	75 mm	5
------------	-------	---

### Dynamic

### Empty Container



· 5,3 L ·

447028	5,3 L	1
--------	-------	---

### Preserva

### Semi-Transparent Stain



· Tint Base ·

43301	828 ml	6
43101	3,31 L	4

- Penetrating oil tint base
- One base for tinting
- Available in quarts and gallons
- 20 colors available (formulas for Universal, Colortrend and PPG colorants available)
- Ideal for horizontal and vertical surfaces



Item #	Size	Qty per cse			Item #	Size	Qty per cse		
--------	------	-------------	--	--	--------	------	-------------	--	--

## Holland

## Pressure Sprayer 8 Liters



· 8 Liters ·		
S010432N	8 Liters	1

## Gotham

## Eco-Solv Lacquer Thinner

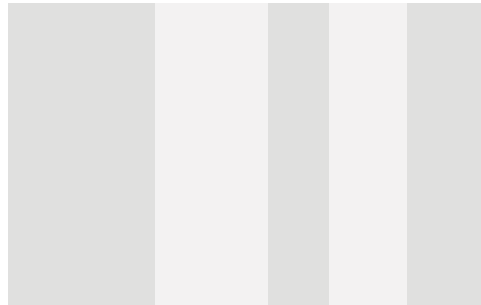

· Meets the new VOC requirement ·		
147-1	946 ml	10
147-4	3,78L	4



Item #	Size	Qty per cse			Item #	Size	Qty per cse		
--------	------	-------------	--	--	--------	------	-------------	--	--

### Meoded

### Base Coat



· For Lime Wash ·

LWBC-1QT	946 ml	4		
LWBC-1G	3,78L	2		

### Meoded

### Lime Wash



· Natural Matte Finish ·

LW-1QT	946 ml	4		
LW-1G	3,78L	2		

- Interior / Exterior
- Natural matte marbled finish
- Soft to the touch
- Creates natural color variation lightly striated
- 80 colors available (Gennex colorant formulas available)

### Meoded

### Stain Defense



· Natural Look Sealer ·

SSS-1QT	946 ml	4		
---------	--------	---	--	--

### Richard

### Inside Corner Taping Roller



R-18700	-	6		
---------	---	---	--	--





Item #	Size	Qty per cse
--------	------	-------------

Item #	Size	Qty per cse
--------	------	-------------

## INSTAGREY

## Wood Treatment

### · Weathered wood effect ·



GRIS-1L	27 g	6
GRIS-1G	55 g	6
GRIS-5G	160 g	6

- Three formats for a yield of 1 Liter, 3,78 Liters or 18,9 Liters
- Fast barn wood greying results
- Interior / Exterior
- Easy to apply
- Ideal for sidings, patio and furniture etc.

## INSTABLACK

## Wood Treatment

### · Burned wood effect ·



NOIR-1L	48 g	6
NOIR-1G	159 g	6

- Two formats for a yield of 1 Liter, 3,78 Liters
- Fast burned wood effect results
- Interior / Exterior
- Easy to apply
- Ideal for sidings, patio and furniture etc.

## Metallic Powder Colorant

## Epoxy Colorant

## Metallic Powder Colorant

### · 40 grams ·

DED100	Silver Pearl	12
DED101	Iridescent White	12
DED306	Olympic Gold	12
DED500	Bronze	12
DED510	Coffe	12
DED6080	Copper Brown	12
DED6091	Black Grey	12



### · 40 grams ·

DED6093	Satin Grey	12
DED6094	Satin White Grey	12
DED6414	Cobalt Blue	12
DED6914	Black Pearl	12
DED7102	Satin White	12
DED7415	Synstar Red	12

## Mask

## KN95

### · 95% Efficiency ·

CS-KN95	-	10
---------	---	----



- Sold in multiple of 10



Item #	Size	Qty per cse	Item #	Size	Qty per cse
--------	------	-------------	--------	------	-------------

### DAP

### Sharpshooter D



· For Insulating Foam ·  
7565070235 - 1

### Soudal

### Compact Foam Gun



· For Insulating Foam ·  
109953 - 1

### Soudal

### Caulking Gun



· For 300 ml Tubes ·  
106617 300 ml 1

### Siligun4

### Caulking Gun



· No drip caulking gun ·  
SILIGUN4 - 10

- No rod
- 4" compact gun
- Caulk in tighter spaces
- Easy to store in toolbox
- Cut off excess tube
- Easy to use

# Our Mission

DFM is  
the one who brings  
people together,  
the expert and leader  
to the paint retailers  
by valuing discipline,  
respect and service  
that guarantees results  
for all



- 01**
- Terms and conditions

- 02**
- Applicators
  - Artist Paint Brushes
  - Brushes

- 03**
- Accessories
  - Roller Frames
  - Roller Refills

- 04**
- Liner
  - Roller & Tray Paint Kit
  - Tray

- 05**
- Cutters
  - Extension Poles
  - Knives
  - Scraper
  - Steel Brushes
  - Tools

- 06**
- Caulking
  - Caulking Gun
  - Glue
  - Plaster
  - Plastic Wood
  - Sand Paper
  - Spackling
  - Steel Wool
  - Tape
  - Wrapping

- 07**
- Buckets
  - Cleaners
  - Dickies
  - Drop Sheet
  - Gloves
  - Painters Accessories
  - Plastic Rolls
  - Rags
  - Safety Products
  - Sponges
  - T.S.P.
  - Wippers

- 08**
- Foam Insulation
  - Primers
  - Remover
  - Specialised Paints
  - Spray Paints
  - Thinner
  - Wood finishing
  - Wallpaper Accessories
  - Wallpaper Adhesive
  - Wallpaper Remover

- 09**
- Anti-Slip additive
  - Cabot
  - Dex
  - Exterior Stain
  - Fix All
  - Old Masters
  - Ready Seal
  - Storm Stain

- 10**
- Epoxy accessories
  - Epoxy Squeegee
  - DIY 100% solid Epoxy
  - Vinyl Flakes, Tint & Pigments for Epoxy

- 11**
- Industrial Products
  - Products for Professional use only

- 12**
- Passeport Elite Products





**DFM**  
INTERNATIONAL

# GROWTH STRENGTH EXCELLENCE

## SECTION 01

- Informations
- Terms & Conditions

## · INFORMATIONS ·

**Opening Hours**  
**Monday to Friday**  
**8h30 am to 4h30 pm**

**420, Industrial Blvd, Suite 100**  
**St-Jean-sur-Richelieu (Qc)**  
**J3B 4S6**

**Phone: 450 349-2226 • 1 877 989-2226**

**Fax: 450 349-1799 • info@distdfm.com**

## · TERMS & CONDITIONS ·

- Payment terms :** 1,5 % 10 days, Net 30 days.  
A 2% monthly charge will be added to all past due amounts .
- Prices :** Prices may change WITHOUT PRIOR NOTICE.  
Check out your e-mail to get our monthly update.
- Claim :** Any shortage, damage or error must be reported within 7 days following delivery of your order.  
Any damaged merchandise must be mentioned on the proof of delivery to be claimed.
- Returns :** No Return will be accepted without prior written authorization.  
All merchandise return is subject to a 20% restocking charge  
No return will be accepted in any case on special order products.  
(Product code preceded by CS-)
- Taxes :** Prices does not include applicable taxes or eco-fees.
- Pick Up Orders :** All pick up orders must be placed by phone, fax or e-mail **24 hours** before showing up for pick up
- Transport :** We will not take charge of any transport by ship or other particular nature or remote areas.  
Please verify with one of our customer service representative for more details.  
Dangerous goods special handling fees will be charged when applicable.  
All special order, once received at the DFM Warehouse, must meet the minimum amount for pre-paid shipment ( it can be paired with a new order) otherwise, transport will be at your cost.  
**All orders could require 24 to 48 hours to be shipped.**
- Heated Transport :** Heated transport service fees will be added for any delivery requiring it.
- Paint & Liquid Goods Transportation:** All orders including liquid products from the following brands must be a minimum of 60 gallons or \$1000.00\*\* to get prepaid shipment. If not, DFM will not be responsible for any damage on this shipment.  
**Any type of epoxy, Rust-Oleum Industrial, STEINA, Ready Seal, Cabot, California Paints, Zinsser**
- \*\*These product can be mix with any products included in the DFM catalogue to get the required minimum prepaid.**

Region	Minimum Prepaid
<b>Minimum order for Collect, FOB or pick up orders</b>	\$ 75.00
Ontario	\$ 550.00
New-Brunswick	\$1000.00



**DFM**  
INTERNATIONAL

# GROWTH STRENGTH EXCELLENCE

## SECTION 02

- Applicators
- Artist Paint Brushes
- Paint Brushes



Item #	Size	Qty per cse	<b>BRUSHES</b>			Item #	Size	Qty per cse
--------	------	-------------	----------------	--	--	--------	------	-------------

### 100% Nylon

### Aquaglide

### Nylon

· Wall Brush ·						· Angular ·		
1850-37N	37mm	10			1851-25N	25mm	10	
1850-50N	50mm	10			1851-37N	37mm	10	
1850-60N	60mm	10			1851-50N	50mm	10	
1850-75N	75mm	10			1851-63N	63mm	10	
1850-100N	100mm	5			1851-75N	75mm	10	

### Polyester / Nylon

### PolyMaster / Tradition

### Polyester / Nylon

· Angular ·						· Angular ·		
4851-37N	37mm	10			1881-37NT	37mm	10	
4851-50N	50mm	10			1881-50NT	50mm	10	
4851-63N	63mm	10			1881-63NT	63mm	10	
4851-75N	75mm	10			1881-75NT	75mm	10	

### NOUR

### Tradition Chinex/Nylon

						· Angular Firm Flex ·			
									
				1891-37NT	37mm	10			
				1891-50NT	50mm	10			
				1891-63NT	63mm	10			
				1891-75NT	75mm	10			

### Heritage

### Tynex / Orel

						· Angular ·			
									
				3881-25N	25mm	10			
				3881-37N	37mm	10			
				3881-50N	50mm	10			
				3881-63N	63mm	10			
				3881-75N	75mm	8			



Item #	Size	Qty per cse			Item #	Size	Qty per cse		
--------	------	-------------	--	--	--------	------	-------------	--	--

### Nour

### Bristle Blend



· Angular ·		
751-37N	37 mm	15
751-50N	50 mm	12
751-63N	63 mm	15
751-75N	75 mm	12

### Nour

### Thin Wall Brush Bristle Blend



· Wall Brush ·		
755-37N	37 mm	20
755-50N	50 mm	10
755-75N	75 mm	10
755-100N	100 mm	5

### Nour

### Synthetic Blend



· Angular ·		
2771-37N	37 mm	15
2771-50N	50 mm	12
2771-63N	63 mm	15
2771-75N	75 mm	12

### Nour

### Synthetic Blend



· Wall Brush ·		
2775-37N	37 mm	20
2775-50N	50 mm	10
2775-75N	75 mm	10
2775-100N	100 mm	5



Item #	Size	Qty per cse	<b>BRUSHES</b>			Item #	Size	Qty per cse
--------	------	-------------	----------------	--	--	--------	------	-------------

### Banff Black Bristle

### Nour

### Jasper Poly/Nylon

• Angular •

RV16125	25mm	20
RV16137	37mm	16
RV16150	50mm	12
RV16163	63mm	12
RV16175	75mm	10



• Angular •

3661-37N	37mm	16
3661-50N	50mm	12
3661-63N	63mm	12
3661-75N	75mm	10

### Elegance Paint Brush Series

### Richard / Nour

### Aquaglide Rat Tail

• Polyester •

80839	1"	12
80840	1-1/2"	6
R-80841	2"	6
80842	1-1/2"	6



• Professionnal •

1853-37NRT	37mm	18
1853-50NRT	50mm	14
1853-63NRT	63mm	10
1853-75NRT	75mm	8

### Wooster

### Ultra Short/Aquaglide Micro

### Nylon

• Shortcut 2" •

Q3211	50mm	12
-------	------	----

- Display Box included when purchase by case



• Angular •

1853-37N	37mm	24
1853-50N	50mm	20
1853-63N	63mm	20
1853-75N	75mm	16

- Short Handle

### Goose Neck Paint Brush

### Nour

### Black Bristle Wall Brush

• Flexible Handle Angular •

80833	2-1/2"	6
-------	--------	---



• Bent Radiator •

RV50537	37mm	15
RV50550	50mm	12



Item #	Size	Qty per cse	<b>BRUSHES</b>			Item #	Size	Qty per cse
--------	------	-------------	----------------	--	--	--------	------	-------------

### Black Bristle

### Master

### Black Bristle

· Wall Brush ·			· Angular ·			
850-30N	30mm	20		851-37N	37mm	10
850-50N	50mm	10		851-50N	50mm	10
850-63N	63mm	10		851-63N	63mm	10
850-75N	75mm	10		851-75N	75mm	10
850-100N	100mm	5				

### Legacy

### White Bristle

			· Angular ·		
			871-37NT	37mm	10
			871-50NT	50mm	10
			871-63NT	63mm	10
			871-75NT	75mm	10

### Tradition

### Black Bristle

			· Angular ·		
			881-25NT	25mm	10
			881-37NT	37mm	10
			881-50NT	50mm	10
			881-63NT	63mm	10
			881-75NT	75mm	10



Item #	Size	Qty per cse	<b>BRUSHES</b>			Item #	Size	Qty per cse
--------	------	-------------	----------------	--	--	--------	------	-------------

### Varnish

### Black Bristle

						<b>· Wall Brush ·</b>					
						900-75N	75mm	10			
						900-100N	100mm	5			

### Poly/Nylon

						<b>· Wall Brush ·</b>					
						4600-30N	30mm	20			
						4600-50N	50mm	10			
						4600-75N	75mm	10			

### Polyester

### Better Quality Consumer

### Polyester

<b>· Wall Brush ·</b>			 			<b>· Angular Sash ·</b>		
1300-75N	75mm	12				1351-30N	30mm	15

### Synthetic Blend

### Consumer D.I.Y.

### White Bristle

<b>· Wall Brush ·</b>			 			<b>· Angular Sash ·</b>					
1050-25N	25 mm	12				351-50N	50mm	12			
1050-50N	50 mm	12									
1050-75N	75 mm	12									





Item #	Size	Qty per cse	<b>BRUSHES</b>			Item #	Size	Qty per cse
--------	------	-------------	----------------	--	--	--------	------	-------------

### Black Bristle

### Best Quality

### White Bristle

· Wall Brush ·			· Wall Brush ·			
RV2130	30mm	20	 	300-30N	30mm	20
RV2150	50mm	12				
RV2175	75mm	12				
RV21100	100mm	6				

### Best Quality

### Black Bristle

			· Wall Brush ·			
				400-75N	75mm	10

### Brush & Roller Cleaner

### Dynamic / Nour

### Brush Comb

· 2 in 1 Tool ·			· Economy ·			
DYN279	-	10	 	RVCOMB		10



Item #	Size	Qty per cse
--------	------	-------------

## BRUSHES

Item #	Size	Qty per cse
--------	------	-------------

### Colmatch

### 1" Foam Applicator



Item #	Size	Qty per cse
Colmatch	1000	1
<ul style="list-style-type: none"> <li>• Sold by the case only</li> </ul>		

### Polyester



Item #	Size	Qty per cse
RV26-3	3 Pk	12
<ul style="list-style-type: none"> <li>• Set of 3", 2"1/2 and 1"1/2 Polyester Wall Brushes</li> </ul>		

### Natural Bristle



Item #	Size	Qty per cse
20-30N-5	30mm	6
<ul style="list-style-type: none"> <li>• 1.2" / 30mm</li> </ul>		



Item #	Size	Qty per cse	<b>BRUSHES</b>			Item #	Size	Qty per cse
--------	------	-------------	----------------	--	--	--------	------	-------------

### Polyester Wall Brush

### Nour

### White Bristle Wall Brush

· Polyester ·			· Stain Brush ·				
RV3675	75mm	15			RV3175	75mm	15
RV36100	100mm	6			RV31100	100mm	6

### Threaded Handle

### Woodcare Brush

### Wall Brush

· Woodcare ·			· Woodcare ·				
RV32100	100mm / 4"	8			RV3375	75mm	15
RV32150	150mm / 6"	3			RV33100	100mm	6

### Stain Brush

### Nour

### Stain Brush

· Threaded Handle ·			· Synthetic Blend ·				
37-100	100mm	6			38-75	75mm	12
37-125	125mm	6			38-100	100mm	12
<ul style="list-style-type: none"> <li>• Threaded handle for extension pole use</li> </ul>							

### Nour

### Woodcare Brush

· Threaded Angular Handle ·			
39-120	120mm	6	
39-175	175mm	6	



Item #	Size	Qty per cse	<b>BRUSHES</b>			Item #	Size	Qty per cse
--------	------	-------------	----------------	--	--	--------	------	-------------

### Throwaway Brush

### Simms / Nour

### Throwaway Brush

· White Bristle ·

9900-50	50mm	24		
---------	------	----	--	--



· Multiple use ·

R030-30	30mm	36		
R030-50	50mm	36		
R030-75	75mm	12		
R030-100	100mm	12		

### Economy

### Throwaway Brush



· White Bristle Wall Brush ·

890	1/2"	24		
891	1"	24		
893	2"	12		
895	3"	12		
896	4"	12		

### White Bristle

### Economy

### Scout Brush

· Plastic Handle-Wall Brush ·

R010-15	15mm	24		
R010-30	30mm	24		
R010-50	50mm	12		
R010-75	75mm	12		
R010-100	100mm	12		



HB160003	30mm	50		
HB160005	50mm	40		
HB160007	75mm	20		

### Richard

### Mars Paint Brush Series



· Polyester Brush ·

80001	1/2"	20		
80002	1-1/4"	20		
80003	2"	20		
80004	3"	10		
80005	4"	10		



Item #	Size	Qty per cse	<b>CHALK PAINT BRUSH</b>			Item #	Size	Qty per cse
--------	------	-------------	--------------------------	--	--	--------	------	-------------

Chalk Paint Brush			Nour			Chalk Paint Brush		
						<b>Round</b>		
1278-25NC	25mm	16			1278-37NC	37mm	9	

Chalk Paint Brush			Nour			Chalk Paint Brush		
						<b>· Palm Brush ·</b>		
1268-50NC	50mm	8			1338-37NC	37mm	8	
						<b>Oval</b>		

Chalk Paint Brush			Nour			Chalk Paint Brush		
						<b>· Angular ·</b>		
1333-37NC	37mm	16			1330-37NC	37mm	14	
						<b>· Flat ·</b>		

Touch up Trimmer Brush			Nour			Touch up Trimmer Brush		
						<b>· Polyester ·</b>		
1475-19	19mm	16			RV47519		36	
						<b>· Natural Black Bristle ·</b>		
						<ul style="list-style-type: none"> <li>• Pour retouches et garnitures</li> </ul>		



Item #	Size	Qty per cse	<b>BRUSHES</b>	Item #	Size	Qty per cse
--------	------	-------------	----------------	--------	------	-------------

### Wooster

### Ultra Pro Firm Lindbeck



· Angular ·

4174-37	37mm	6
4174-50	50mm	6
4174-63	63mm	6
4174-75	75mm	6

### Silver Tip Brush

### Wooster

### Ultra Pro Extra Firm Lindbeck

63mm / 2-1/2"

5221-37	37mm	6
5221-50	50mm	6
5221-63	63mm	6
5221-75	75mm	6



· Angular ·

4153-50	50mm	6
4153-65	63mm	6
4153-75	75mm	6

### Nylon Polyester

### XL-Glide / XL-Swan

### Nylon Polyester

· Angular ·

152315	1 1/2"	6
152320	2"	6
152325	2 1/2"	6
152330	3"	6



· Wall ·

400330	3"	6
--------	----	---

- Beaver Tail Handle

### Purdy

### Pro Extra Tynex Polyester



· Angular ·

152720	2"	6
152725	2 1/2"	6
152730	3"	6



Item #	Size	Qty per cse	<b>BRUSHES</b>			Item #	Size	Qty per cse
--------	------	-------------	----------------	--	--	--------	------	-------------

### Nour

### Foam Brush



#### · Straight ·

RFB25	1"	48
RFB50	2"	48
RFB75	3"	36
RFB100	4"	24

#### · 3 Pack · 1"-2"-3"

RFB-3		24
-------	--	----

### Polyester SRT Filaments

### Nour

### Polyester SRT Filaments

#### · Straight Sash ·

1335-50N	50mm	10
1335-63N	63mm	12
1335-75N	75mm	10



#### · Oval Pro ·

1336-37N	37mm	10
1336-50N	50mm	10
1336-63N	63mm	10
1336-75N	75mm	10

### Polyester SRT Filaments

### Nour

### Polyester SRT Filaments

#### · Assorted 3 Pack ·

1331-3N		10
---------	--	----

Includes :

- 2 each of 37mm trim brush
- 1 of 50mm brush



#### · Angular ·

1331-37N	37mm	16
1331-50N	50mm	12
1331-63N	63mm	12
1331-75N	75mm	10

### Nour

### Perfect Finish



#### · Super sharp tip ·

5451-37N	37mm	16
5451-50N	50mm	12
5451-63N	63mm	12
5451-75N	75mm	10



Item #	Size	Qty per cse	Item #	Size	Qty per cse
--------	------	-------------	--------	------	-------------

### Craft Brush Set

### Richard / Nour

### Craft Brush Set

· 5 Piece Set ·							
80018	5 Pcs	12			RRB-5	5 pack	12

### Richard

### Craft Brush

			· For Crafters ·					
						80011	1/8"	12
						80012	1/4"	12
						80013	3/8"	12
						80014	1/2"	12
						80015	5/8"	12
						80016	3/4"	12

### Richard

### Round Paint Brush

			· Wood Handle ·					
						13715	5/8"	6
						13718	3/4"	6
						13721	7/8"	6
						13725	1"	6
						13729	1-1/8"	6

### Richard

### Rocker Wood Grainer

			· Carded ·					
						RG-1	-	5





Item #	Size	Qty per cse	Item #	Size	Qty per cse
--------	------	-------------	--------	------	-------------

Richard

9 in Applicator



· For patio and Stain ·

95026	9 in	6
-------	------	---

Richard

9 in Replacement Pad



· For patio and Stain ·

95027	9 in	6
-------	------	---

Richard

7 in Applicator



· For patio and stain ·

95028	7 in	6
-------	------	---

Richard

7 in Replacement Pad



· For 95022 applicator ·

95023	7 in	6
-------	------	---



Item #	Size	Qty per cse			Item #	Size	Qty per cse		
--------	------	-------------	--	--	--------	------	-------------	--	--

Richard

7 in Paint Applicator

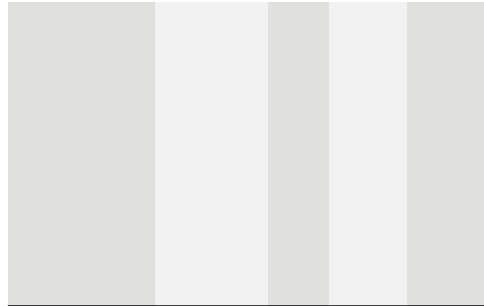

· For Interior Paints ·				
95020	7 in	6		

Richard

1 in applicator



· For Touch up and Trims ·				
95018	2,5 cm	12		

Richard

Replacement Pads



· 3 Pack ·				
95028	2,5 cm	12		



Item #	Size	Qty per cse	<b>APPLICATORS</b>			Item #	Size	Qty per cse
--------	------	-------------	--------------------	--	--	--------	------	-------------

Richard

Trimming Tool

· For Telescopic Extension ·



95504

10

Richard

Trimming Tool

· Plastic ·



95503

12

Richard

Replacement Pads

· For Trimming Tool ·



95502

2 Pack

12

- Replacement pad for 95503 and 95504



**DFM**  
INTERNATIONAL

# GROWTH STRENGTH EXCELLENCE

## SECTION 03

- Applicator
- Roller Frame
- Roller Refill



Item #	Size	Qty per cse	ROLLER REFILL			Item #	Size	Qty per cse
--------	------	-------------	---------------	--	--	--------	------	-------------

### Nour

### Deluxe



· Polyester fabric ·

Z9C05	5mm	180		
Z9C10	10mm	140		

### Nour

### Super Deluxe Refill



· Economy ·

Z9A10	10mm	10		
-------	------	----	--	--

190mm / 7 1/2"

Top Pro

240mm / 9 1/2"

· Professional Polyester Fabric ·

Z7AP10	10mm	10		
--------	------	----	--	--

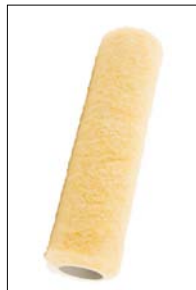

· Professional Polyester Fabric ·

Z9AP10	10mm	10		
Z9AP15	15mm	10		
Z9AP20	20mm	10		
Z9AP30	30mm	10		

190mm / 7 1/2"

Tradition

240mm / 9 1/2"

· Lint Free Polyester Nylon ·

Z7T05NT	5mm	10		
Z7T10NT	10mm	10		
Z7T15NT	15mm	10		



· Lint Free Polyester Nylon ·

Z9T05NT	5mm	180		
Z9T10NT	10mm	140		
Z9T13NT	13mm	120		
Z9T15NT	15mm	120		
Z9T20NT	20mm	100		
Z9T25NT	25mm	80		



Item #	Size	Qty per cse	<b>ROLLER REFILL</b>			Item #	Size	Qty per cse
--------	------	-------------	----------------------	--	--	--------	------	-------------

**Deluxe**

240mm / 9 1/2"

**Deluxe**

· Economy 3 Pack ·

Z9C10-3	10mm	50		
---------	------	----	--	--



· Economy 4 Pack ·

Z9C10-4	10mm	35		
---------	------	----	--	--

**Decorator**

240mm / 9 1/2"

**Decorator**

· Lint Free 3 Pack ·

Z9N10-3	10mm	50		
---------	------	----	--	--



· Lint Free 2 Pack ·

Z9N10-2	10mm	70		
---------	------	----	--	--

**Tradition**

240mm / 9 1/2"

**Decorator**

· Professional 10 Pack ·

Z9T10-10	10mm	14		
Z9T15-10	15mm	12		



· Lint Free 4 Pack ·

Z9N10-4	10mm	35		
---------	------	----	--	--

**Nour**

**Economy Refill**

--	--	--	--	--



Z9D10	10mm	70		
-------	------	----	--	--



Item #	Size	Qty per cse	<b>ROLLER REFILL</b>			Item #	Size	Qty per cse
--------	------	-------------	----------------------	--	--	--------	------	-------------

### Wound Foam Refill

### Nour

### Foam Refill

· 3mm X 240mm / 9 1/2" ·						· 10mm x 240mm / 9 1/2" ·		
Z9WF05	5mm	10			Z9F10	10mm	10	

### Split Foam Refill

### Nour

### Simulated Mohair

· 13mm x 240mm / 9 1/2" ·						· 5mm x 240mm / 9 1/2" ·		
Z9SF13	13mm	10			Z9M05	5mm	10	
· 20mm x 240mm / 9 1/2" ·					Z9SF20	20mm	10	

### Nour

### Texture Refill

						· For Very Smooth Surface ·			
							Z9NTX05	5mm	10

### Decorator

### Lint Free

### Heritage Extreme Finish

· 10mm x 240mm / 9 1/2" ·						· High Density Lint Free ·		
Z9N10	10mm	140			Z9HE10	10mm	10	
· 13mm x 240mm / 9 1/2" ·					Z9HE15	15mm	10	
· 3 Pack ·					Z9N15-3	13mm	40	



Item #	Size	Qty per cse	ROLLER REFILL			Item #	Size	Qty per cse
--------	------	-------------	---------------	--	--	--------	------	-------------

### Wooster

### Jumbo Koter Pro/Doo-Z



· 2-Pack ·		
RR302-4 1/2	-	12

### Super/Fab

### Wooster

### Pro/Doo-Z

· 3/8" / 10mm ·		
KR239	-	20



· 3/16" / 5mm ·		
KR641	-	12

· 1/2" / 15mm ·		
KR240	-	18

· 3/8" / 10mm ·		
KR642	-	20

· 1/2" / 15mm ·		
KR643	-	18

### Nour

### Epoxy Roll Pro 9"



· For Epoxy and Urethane ·		
Z9ERP10	10mm	10
Z9ERP15	15mm	10

### Wooster

### Epoxy Glide



· Professional ·		
KR232-9 1/2	9 1/2"	20
-	-	-





Item #	Size	Qty per cse	3" & 4"			Item #	Size	Qty per cse
--------	------	-------------	---------	--	--	--------	------	-------------

75mm / 3"

· Junior Roller With Handle ·			· Junior Refill ·				
Z3TJ05H	-	20			Z3TJ05-2	-	20

3" Lint Free Roller

75mm / 3"

3" Lint Free Refill

· With Cage Handle ·			· 3" / 75mm ·				
Z3T05CH	5mm	20			Z3T05	5mm	20
Z3T10CH	10mm	20			Z3T10	10mm	20

4" Lint Free Roller



100mm / 4"

4" Lint Free Refill



· With Cage Handle ·			· 4" / 100mm ·				
Z4T05CH	5mm	20			Z4T05	5mm	20
Z4T10CH	10mm	20			Z4T10	10mm	20
Z4T15CH	15mm	20					

Economy Refill

Lint Free Refill

· 3" x 10mm ·			· 4" x 15mm ·				
Z3S10	10mm	10			Z4T15	15mm	10
<ul style="list-style-type: none"> <li>No UPC Code On Packaging</li> <li>Sold by multiples of 10 only</li> </ul>					<ul style="list-style-type: none"> <li>No UPC Code On Packaging</li> <li>Sold by multiples of 10 only</li> </ul>		
· 4" x 10 mm ·							
Z4S10	10mm	10					
<ul style="list-style-type: none"> <li>No UPC Code On Packaging</li> <li>Sold by multiples of 10 only</li> </ul>							



Item #	Size	Qty per cse	<b>ACCESSORIES</b>			Item #	Size	Qty per cse
			<b>3" / 75mm</b>			<b>Foam Refill</b>		
						<b>· 3" x 10mm ·</b>		
						CS-Z3F10	10mm	20
<b>2" Foam Roller Refill</b>			<b>Microfiber</b>			<b>Microfiber 4" Refill</b>		
						<b>· 10-Pack ·</b>		
Z2U10-2	10mm	20				Z4UMF10-10	10mm	10
								



Item #	Size	Qty per cse	<b>ULTRA ROLLER SYSTEM</b>			Item #	Size	Qty per cse
--------	------	-------------	----------------------------	--	--	--------	------	-------------

### Pro Ultra With Handle

### Pro Ultra Fabric

### Pro Ultra Fabric Refill

<ul style="list-style-type: none"> <li>• 100mm / 4" •</li> </ul>						<ul style="list-style-type: none"> <li>• 110mm / 4" •</li> </ul>		
Z4U05H	5mm	10			Z4U05	5mm	20	
<ul style="list-style-type: none"> <li>• 12" Ultra Handle</li> </ul>						Z4U05-2	5mm	20
						Z4U05-10	5mm	11
						<ul style="list-style-type: none"> <li>• 160mm / 6" •</li> </ul>		
						Z6U05-2	5mm	20

### Ultra Foam Refill w/ Handle

### High Density Foam

### 4" Ultra Foam Refill

<ul style="list-style-type: none"> <li>• Economy •</li> </ul>						<ul style="list-style-type: none"> <li>• 100mm / 4" •</li> </ul>		
Z4U10H	10mm	10			Z4U10	10mm	20	
<ul style="list-style-type: none"> <li>• 12" Ultra Handle</li> </ul>						Z4U10-2	10mm	20

### All Purpose Ultra fabric

### 10-Pack Refills

### High Density Foam

<ul style="list-style-type: none"> <li>• 100mm / 4" •</li> </ul>						<ul style="list-style-type: none"> <li>• 100mm / 4" •</li> </ul>		
Z4UY05-10	5mm	1			Z4UPP10-10	10mm	10	
<ul style="list-style-type: none"> <li>• 150mm / 6" •</li> </ul>								
Z6UY05-10	5mm	1						

### Ultra Handle

### Flocked Foam Refill

<ul style="list-style-type: none"> <li>• 12" •</li> </ul>						<ul style="list-style-type: none"> <li>• 2 Pack •</li> </ul>		
ZFR12U	-	10			Z4UF10-2	10mm	10	
<ul style="list-style-type: none"> <li>• 16" •</li> </ul>						Z6UF10-2	10mm	10
ZFR16U	-	10						
<ul style="list-style-type: none"> <li>• 26" •</li> </ul>								
ZFR26U	-	10						
<ul style="list-style-type: none"> <li>• To be used with Ultra Roller Refill</li> </ul>								



Item #	Size	Qty per cse	<b>ROLLER FRAME</b>			Item #	Size	Qty per cse
--------	------	-------------	---------------------	--	--	--------	------	-------------

### 3" and 4" Cage Frames

### Consumer

### 5 Wire Frame

· 75mm / 3" et 100mm / 4" ·

RZFR43	3"	24
RZFR44	4"	24



· 190mm / 7 1/2" ·

ZFR479N	7 1/2"	20
---------	--------	----

· 240mm / 9 1/2" ·

ZFR499N	9 1/2"	24
---------	--------	----

### Roller Lock

### DIY Cage Frame



· 240mm / 9 1/2" ·

ZFR951	9 1/2"	20
--------	--------	----

- Roller Lock Patented System Prevents Roller Refill Slippage During Use

### Pro Cage Frame

### Roller Lock

### Pro Heavy Duty Cage Frame

· 240mm / 9 1/2" ·

ZFR952	9 1/2"	20
--------	--------	----

- Roller Lock Patented System Prevents Roller Refill Slippage During Use

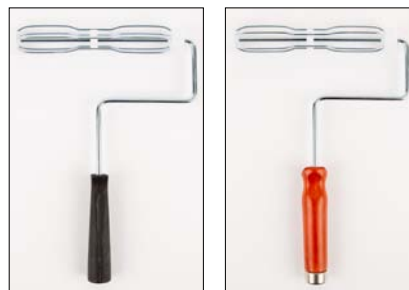

· 240mm / 9 1/2" ·

ZFR953	9 1/2"	10
--------	--------	----

- Roller Lock Patented System Prevents Roller Refill Slippage During Use

### Sherlock Frame

### Wooster

### Jumbo Koter Flip Frame

· 240mm / 9 1/2" ·

R017	9 1/2"	12
------	--------	----



· Professional ·

RR323	-	12
-------	---	----



Item #	Size	Qty per cse	<b>LARGE FRAME</b>			Item #	Size	Qty per cse
--------	------	-------------	--------------------	--	--	--------	------	-------------

### 18" Cage Frame

### Nour



### 5/16" Endcap

<b>· Heavy Duty ·</b>						<b>· End Cap ·</b>		
RZFR1805	18"	1			ZAC21	-	1	
						• Sold by unit		

### 12" to 18" Frame

### Wooster

### Endcap

<b>· Professional ·</b>						<b>· Wooster ·</b>		
BR047	12" to 18"	3			R087	-	24	
• Endcap not included						• End cap for BR045 and BR047 • Sold by unit		

### 12" to 18" Frame

### Simms

### F-160 Endcaps

<b>· Economy ·</b>						<b>· Simms ·</b>		
F-160	12" to 18"	6			4883	-	20	

### 18" Frame

### Dynamic / Wooster

### 18" Big ben

<b>· Economy ·</b>						<b>18"</b>		
HB049140	18"	12			BR045	18"	2	



Item #	Size	Qty per cse	<b>18" APPLICATOR</b>			Item #	Size	Qty per cse
--------	------	-------------	-----------------------	--	--	--------	------	-------------

**Nour**

**Epoxy Roll Pro 18"**

· For Epoxy and Urethane ·



Z18ERP10	10mm	10
Z18ERP15	15mm	10

**18" Top Pro**

**Nour**

**18" Tradition**

· 454mm / 18" ·

· 454mm / 18" ·

Z18AP10	10mm	10
Z18AP15	15mm	10
Z18AP30	30mm	10



Z18T05	5mm	1
Z18T10	10mm	1
Z18T15	15mm	1

**Lint Free MicroFiber Refill**

**Nour**

**18" Microfiber Plus Refill**

18"

18"

Z18MF10	10mm	10
---------	------	----

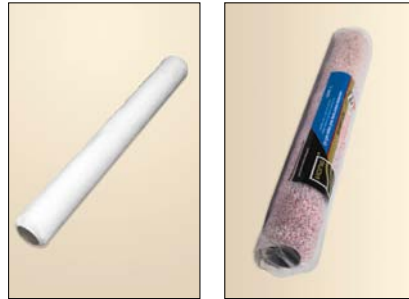

Z18MFB10	10mm	10
Z18MFB13	13mm	10
Z18MFB15	15mm	10

**Wooster**

**18" Pro-Doo-Z**

18"

OR232-18"	18"	6
-----------	-----	---



RR641-18	5mm	6
RR642-18	10mm	1



Item #	Size	Qty per cse	<b>APPLICATORS</b>			Item #	Size	Qty per cse
--------	------	-------------	--------------------	--	--	--------	------	-------------

### Natural Lambswool

### Floor Applicator

### Lambswool Refill

· Natural Lambswool ·

ZFLW610	-	4		
---------	---	---	--	--



ZFLW610R	-	6		
----------	---	---	--	--

· Natural Lambswool ·

### Polywool Floor Applicator

### Floor Applicator

### Polywool Refill

· Polywool ·

ZFLAP610	-	4		
----------	---	---	--	--



ZFLAP610R	-	6		
-----------	---	---	--	--

· Polywool ·

### Flock Foam Applicator

### Floor Applicator

### Flock Foam Refill

· Foam ·

ZFLFF610	-	4		
----------	---	---	--	--



ZFLFF610R	-	6		
-----------	---	---	--	--

· Foam ·

### Finitec

### Applicator

--	--	--	--	--





· Synthetic ·		
86812	6"	12
86814	10"	12

· Refill ·		
86813	6"	12
86815	10"	12

• For oil or waterbased stain or varnish



Item #	Size	Qty per cse	<b>DIVERS</b>				Item #	Size	Qty per cse		
			<b>SIMMS</b>				<b>Rol-Tek Pro Roller</b>				
							F-2200	6	-		
			<b>SIMMS</b>				<b>Rol-Teck End Bearings</b>				
							A-2265	-	12		
			<b>SIMMS</b>				<b>Vintage Pro Sure Fine</b>				
							· 9 1/2" / 240mm ·				
							R-821	10mm	25		
							R-822	13mm	25		





Item #	Size	Qty per cse	<b>ACCESSORIES</b>			Item #	Size	Qty per cse
--------	------	-------------	--------------------	--	--	--------	------	-------------

Ultra Pro Fabric Roller			Ultra Roller			Microfiber Fabric Refill		
<b>16" Handle</b>						<b>2-Pack</b>		
Z4U05HL	4"	10			Z4UMF05-2	4"	20	
<ul style="list-style-type: none"> <li>4" Pro Fabric Roller With 16" Handle</li> </ul>						Z4UMF10-2	4"	20

6" Ultra Refill			Ultra Roller			Microfiber Fabric Refill		
<b>· 6" - 10mm ·</b>						<b>2-Pack</b>		
Z6U10-2	10 mm	20			Z6UMF10-2	6"	20	

Pro Frame			Nour			Pro Frame Encaps		
<b>2 Endcaps included</b>						<b>2-Pack</b>		
ZFR95Y	240mm	10			ZFRYEC-2	-	10	



Item #	Size	Qty per cse	<b>ROLLER REFILL</b>			Item #	Size	Qty per cse
--------	------	-------------	----------------------	--	--	--------	------	-------------

### AquaGlide Plus

### Microfibre Refill

--	--	--	--	--



<b>· 240mm / 9 1/2" ·</b>		
Z9MF10	10mm	10
Z9MF15	15mm	10
Z9MF20	20 mm	100

### 4" Lint Free Microfiber Refill

### AquaGlide Plus

### 3" Lint Free Microfibre Refill

<b>· 2-Pack ·</b>		
Z4MF10-2	10 mm	20



<b>· 2-Pack ·</b>		
Z3MF10-2	10 mm	10

### NOUR

### Aquaglide Microfiber

--	--	--	--	--



<b>3-Pack</b>		
Z9MF10-3BX	10mm	50
Z9MF15-3BX	15mm	40

### Tradition

### NOUR







### Tradition

<b>Phenolic Core Roller</b>		
Z9T05F	5mm	180
Z9T10F	10mm	140



<b>3-Pack</b>		
Z9T10-3BX	10mm	36



Item #	Size	Qty per cse	<b>ROLLER FRAME</b>			Item #	Size	Qty per cse
<b>12" Lint Free Refill</b>			<b>Nour</b>			<b>12" Pro Cage Frame</b>		
· Patented Roller Lock ·						· 12" ·		
ZFR1252	12"	8			Z12T10	10mm	10	
• Plastic Handle					Z12T15	15mm	10	
<b>14" Sherlock Frame</b>			<b>Wooster</b>			<b>14" Pro/Doo-Z</b>		
R017-14"	14"	6			RR642-14"	14" x 10mm	6	
					RR643-14"	14" x 13mm	6	
<b>Barracuda Frame</b>			<b>Simms / Nour</b>			<b>EZ Lock Roller</b>		
· 9 1/2" ·						· Professional 9-1/2" ·		
RF800C	240mm	12			ZFREZ95150	240MM	12	



Item #	Size	Qty per cse	<b>MICROFIBER PLUS</b>			Item #	Size	Qty per cse
--------	------	-------------	------------------------	--	--	--------	------	-------------

### Tradition

### Microfiber Plus Refill



<b>240mm / 9 1/2"</b>		
Z9MFB10	10mm	140
Z9MFB13	13mm	120
Z9MFB15	15mm	120
Z9MFB18	18mm	100

### Tradition

### 18" Microfiber Plus Refill



<b>18"</b>		
Z18MFB10	10mm	10
Z18MFB13	13mm	10
Z18MFB15	15mm	10

### Microfiber Plus Refill 2 Pack

### Tradition

### Microfiber Plus Refill 10 pack

<b>100mm / 4"</b>		
Z4MFB10-2	10mm	10
Z4MFB13-2	13mm	10
Z4MFB15-2	15mm	10



<b>240mm / 9 1/2"</b>		
Z9MFB10-10	10mm	14
Z9MFB13-10	13mm	12

### Tradition

### Microfiber Plus Refill 3 Pack



<b>240mm / 9 1/2"</b>		
Z9MFB10-3BX	10mm	12
Z9MFB13-3BX	13mm	12
Z9MFB15-3BX	15mm	12











**DFM**  
INTERNATIONAL

# GROWTH STRENGTH EXCELLENCE

## SECTION 04

- Liners
- Painting Kit
- Paint Tray



Item #	Size	Qty per cse	TRAY • LINER			Item #	Size	Qty per cse
<b>6" Mini Plastic Tray</b>			<b>1/4 litre</b>			<b>4" Green Plastic Tray</b>		
RZTR350	6"	10			<p><b>· Economy ·</b></p>			
					HZ020440	4"	24	
<b>7" Plastic Tray</b>			<b>1 litre</b>			<b>ZTR30 Liner</b>		
ZTR30	7"	20			<p><b>· Economy ·</b></p>			
					RZTL30	-	50	
<b>Plastic Tray</b>			<b>2 litres</b>			<b>ZTR200 Liner</b>		
ZTR200	10"	20			<p><b>· Economy ·</b></p>			
					RZTL200	-	50	
<b>Plastic Tray</b>			<b>3 litres</b>			<b>ZTR250 Liner</b>		
RZTR250	-	14			<p><b>· Economy ·</b></p>			
					RZTL250	-	50	
						<p><b>· Liner ·</b></p> <ul style="list-style-type: none"> <li>Sold by Multiples of 50 Only</li> </ul>		



Item #	Size	Qty per cse	TRAY • LINNERS			Item #	Size	Qty per cse
--------	------	-------------	----------------	--	--	--------	------	-------------

### Consumer Metal Tray

1 litre

### RZTR90 Liner

• Metal •			• Liner •				
RZTR90	-	20			RZTL90	-	50
			<ul style="list-style-type: none"> <li>Sold by Multiples of 50 Only</li> </ul>				

### Deepwell Metal Tray

2 litres

### RZTR180 Liner

• Metal •			• Liner •				
RZTR180	-	10			RZTL180	-	50
			<ul style="list-style-type: none"> <li>Sold by Multiples of 50 Only</li> </ul>				

### Jumbo Metal Tray

4 litres

### RZTR454 Liner

• Metal •			• Liner •				
RZTR454	-	10			RZTL454	-	50
			<ul style="list-style-type: none"> <li>Sold by Multiples of 50 Only</li> </ul>				

### Simms Super PRO Tray

4 litres

### T-2005 Liner

• Plastic •							
T-2005	-	10			T-2010	-	50
			<ul style="list-style-type: none"> <li>Sold by Multiples of 50 Only</li> </ul>				



Item #	Size	Qty per cse	<b>TRAY • LINERS</b>			Item #	Size	Qty per cse
--------	------	-------------	----------------------	--	--	--------	------	-------------

### Simms Tray

### T-160 Liner

<b>• Holds 2 Litres •</b>						<b>• Liner •</b>		
T-160	-	10			T-165	-	50	<ul style="list-style-type: none"> <li>Sold by Multiples of 50 Only</li> </ul>

### 23" Plastic Tray

### 8 litres

### RZTR850 Liner

<b>• Holds 2 Litres •</b>					<b>• Liner •</b>			
RZTR850	-	10			RZTL850	-	10	<ul style="list-style-type: none"> <li>Sold by Multiples of 10 Only</li> </ul>

### Wooster

### 18" Plastic Tray

				<b>• Big Ben •</b>			
BR412	18"	6		<b>Liner</b>			
R478	18"	12					

### Dynamic

### Disposable Tray

				<b>• 1L •</b>		
HZ020450	-	24				





Item #	Size	Qty per cse	TRIM SET			Item #	Size	Qty per cse
--------	------	-------------	----------	--	--	--------	------	-------------

<b>Foam Set</b>			<b>2" / 4"</b>			<b>Flocked Foam 3-Piece Set</b>		
-----------------	--	--	----------------	--	--	---------------------------------	--	--

· 50mm / 2" ·						· For High Gloss Paint ·		
ZSP2U10	-	20				ZSP4UF310	-	20
						<ul style="list-style-type: none"> <li>For High Gloss Paint, Latex Based or Oil Based</li> </ul>		

			<b>3"</b>			<b>Jr Roller Micro Tray Set</b>		
--	--	--	-----------	--	--	---------------------------------	--	--

						· Economy ·		
						ZSP3TJFIB	-	9
						FORMERLY ZSP3TJ		







<b>4" 4-Piece Set</b>			<b>NOUR</b>			<b>4" 4-Piece Set</b>		
-----------------------	--	--	-------------	--	--	-----------------------	--	--

ZSB4U410	4"	20	<ul style="list-style-type: none"> <li>2 High Density Foam 4" Refill</li> <li>1 Ultra 12" Handle</li> <li>1 Mini Plastic Tray</li> </ul>			ZSB4UY405	4"	20
						<ul style="list-style-type: none"> <li>2 Yellow Stripe Refill 4" X 5mm</li> <li>1 Ultra 12" Handle</li> <li>1 Mini Plastic Tray 1/4 L</li> </ul>		

			<b>NOUR</b>			<b>4" 4-Piece Set</b>		
--	--	--	-------------	--	--	-----------------------	--	--

						<ul style="list-style-type: none"> <li>2 Red &amp; Grey Stripe Refill 4" X 5mm</li> <li>1 Ultra 12" Handle</li> <li>1 Mini Plastic Tray 1/4 L</li> </ul>		
						ZSB4U405	4"	20



Item #	Size	Qty per cse	TRIM KIT			Item #	Size	Qty per cse
<b>4" Tray &amp; Roller Kit</b>			<b>Ultra</b>			<b>4" Tray &amp; Roller Kit</b>		
· 5mm Fabric ·						· 10mm Foam ·		
ZSP4U305	-	20			ZSP4U310	-	20	
<ul style="list-style-type: none"> <li>1/4 L Mini Plastic Tray</li> <li>5mm x 4" Roller with 12" Ultra Handle</li> </ul>						<ul style="list-style-type: none"> <li>1/4 L Mini Plastic Tray</li> <li>10mm x 4" Roller with 12" Ultra Handle</li> </ul>		
<b>4-Piece Trim Kit</b>			<b>Ultra Handle</b>			<b>4-Piece Trim Kit</b>		
· 5mm Fabric ·						· 10 mm Foam ·		
ZSP4U405	-	10			ZSP4U410	10mm	10	
<ul style="list-style-type: none"> <li>1/2 L Plastic Mini Tray with Tray Liner</li> <li>5mm x 4" Roller with 12" Ultra Handle</li> </ul>						<ul style="list-style-type: none"> <li>1/2 L Plastic Mini Tray with Tray Liner</li> <li>10mm x 4" Roller with 12" Ultra Handle</li> </ul>		
<b>3" Lint Free 4-Piece Trim Kit</b>			<b>Cage Frame</b>			<b>4" Lint Free 4-Piece Trim Kit</b>		
· Good Value ·						· Good Value ·		
ZSP3N410	-	10			ZSP4N410	-	10	
<ul style="list-style-type: none"> <li>1/2 L Plastic Mini Tray with Tray Liner</li> <li>10mm x 3" with Cage Frame</li> </ul>						<ul style="list-style-type: none"> <li>1/2L Plastic Mini Tray with Tray Liner</li> <li>10mm x 4" with Cage Frame</li> </ul>		



Item #	Size	Qty per cse	PAINTING KIT			Item #	Size	Qty per cse
--------	------	-------------	--------------	--	--	--------	------	-------------

### Deluxe 3-Piece Kit

### Deluxe / Super Deluxe

### Super Deluxe 4-Piece Kit

**· Economy ·**

ZSP9C310	10mm	10
----------	------	----

- 10mm Deluxe Roller
- Consumer 5 Wire Frame
- 2 L Plastic Tray



**· Good Value ·**

ZSP9A410	10mm	10
----------	------	----

- 10mm Super Deluxe Roller
- Consumer 5 Wire Frame
- 2 L Plastic Tray with Liner

### Nour

### Lint Free 4-Piece Kit

--	--	--



**· Good Value ·**

ZSP9N410	10mm	10
----------	------	----

- Lint Free 9 1/2" 10mm
- Professional 5 Wire Cage
- 2 L Plastic Tray with Liner

### Nour

### Brilliant Finish 8-Piece Kit

--	--	--



**· 8 PCS ·**

ZSR9T810	-	10
----------	---	----

- Includes :
  - 2 L Plastic Tray
  - 2 L Plastic Liner
  - 1 Lint Free Refill 3" / 75mmx10mm
  - 2 Lint Free Refill 9 1/2" / 240mmx10mm
  - Cage Frame 3" / 75mm
  - Roller Lock Cage Frame 9 1/2" / 240mm
  - Brilliant Paint Brush 1 1/2" / 37mm



Item #	Size	Qty per cse	MISC	Item #	Size	Qty per cse
--------	------	-------------	------	--------	------	-------------

### Simms

### T-300 Liner



<b>· Jumbo 4L ·</b>		
T-320	-	50
<ul style="list-style-type: none"> <li>• Roller Tray Liner For T-300</li> </ul>		

### Simms

### Trim Roller Plastic Tray

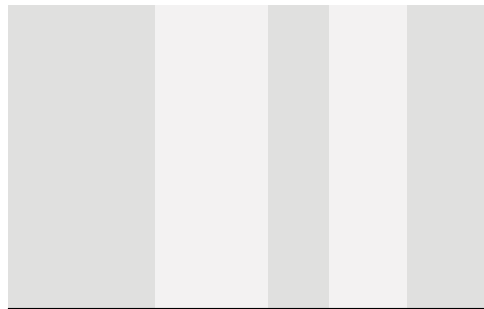

<b>· 75mm / 3" ·</b>		
T-050	0,3L	100

### Simms

### Tray Cover



<b>· For T-2005 ·</b>		
T-2015	-	25

### Simms

### Tray Arm Simms



<b>· Tray Lifting Tool ·</b>		
A-2007	-	5
<ul style="list-style-type: none"> <li>• Tray Not Included</li> </ul>		



**DFM**  
INTERNATIONAL

# GROWTH STRENGTH EXCELLENCE

## SECTION 05

- Extention Poles
- Knives
- Putty Knives
- Scrapers
- Steel Wire Brushes
- Tools



Item #	Size	Qty per cse	<b>EXTENTION</b>			Item #	Size	Qty per cse
--------	------	-------------	------------------	--	--	--------	------	-------------

### Epoxy Coated Metal Pole

### Dynamic / Nour

### Wood Handle

HZ17311P	54"	12		
----------	-----	----	--	--



ZAC48M	48"	10		
ZAC54M	54"	10		
ZAC60M	60"	10		

### Fiberglass & Aluminum Poles

### Nour

### Aluminum Poles

<b>Professional</b>				
REP1	1' x 2'	12		
REP2	2' x 4'	12		
REP4	4' x 8'	12		
REP6	6' x 12'	12		
REP8	8' x 16'	12		

- Threaded Metal Tip



<b>Econo</b>				
REEP2	2' x 4'	24		
REEP3	3' x 6'	24		
REEP4	4' x 8'	24		

- Aluminum
- Threaded Metal Tip

### Sherlock Extension Poles

### Wooster

### Sherlock GT Convertible

R053	1' à 2'	6		
R054	2' à 4'	6		
R055	4' à 8'	6		
R056	6' à 12'	4		
R057	8' à 16'	3		

- Pin-lock System
- Threaded Metal Tip



R090	2' à 4'	6		
R091	4' à 8'	6		
R092	6' X 12'	3		
R096	8' X 16'	3		
R097	1' X 2'	6		

- Convertible Tip Included

### IMPORTANT NOTICE

PLEASE TAKE NOTE THAT AN EXTRA TRANSPORTATION FEE OF \$6.00 WILL BE CHARGED FOR ANY MERCHANDISE EXCEEDING 4' WHICH CANNOT BE WRAPPED ON A STANDARD SKID AND HAS TO BE TREATED MANUALLY.



Item #	Size	Qty per cse	ACCESSORIES			Item #	Size	Qty per cse
--------	------	-------------	-------------	--	--	--------	------	-------------

### Conversion Tip

### Wooster

### Sherlock Maintenance Kit

· From Bayonet to Threaded Tip ·

R042 - 3

- Sherlock GT Conversion Tip
- Converts a Bayonet Tip To a Threaded Tip

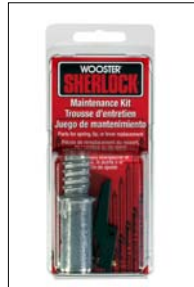

· Sherlock Maintenance Kit ·

FR950 - 3

### Bayonet Tip Replacement Kit

### Klump Tite Adapter

· For Sherlock GT ·

FR068 - 3

- Replacement Part for Sherlock GT



· For Wood Poles ·

HZ002400 - 20

- For Wood Poles

### Marshalltown

### Racatac

3" Casters

11094 - 1



### Sonin

### Moisture Test Tool

50210 - 1





Item #	Size	Qty per cse	OLFA			Item #	Size	Qty per cse
--------	------	-------------	------	--	--	--------	------	-------------

### A-1

### Utility Knife

### L-2

#### · Slide Lock ·

5023 - 6

- Slide Lock Utility Knife



#### · Rubber Grip ·

5004 - 6

- Rubber Inset Utility Knife

### SVR-2

### Utility Knife

### L-1

#### · Auto Lock ·

5019 - 6

- Stainless Steel Auto-Lock Utility Knife



#### · Ratchet Lock ·

5003 - 6

- Ratchet Lock Utility Knife

### 180

### Utility Knife

### SL-1

#### · Economy ·

5001 - 6

- Multi-Purpose Metal Handle Utility Knife



#### · Slide Lock ·

9038 - 6

- Slide Lock Utility Knife

### AB

### Snap-Off Blades

### LB

#### · 50 Pack ·

5015 - 6

- For A-1 / SVR-2 / 180



#### · 50 Pack ·

5016 - 6









Item #	Size	Qty per cse			Item #	Size	Qty per cse		
--------	------	-------------	--	--	--------	------	-------------	--	--

### Olfa

### Replacement blades

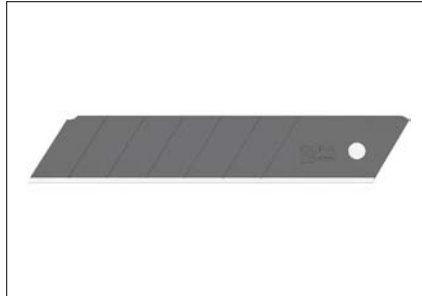

		<b>· 5 pack ·</b>							
1125383	25mm	6							
<ul style="list-style-type: none"> <li>• HBB-5B blades</li> <li>• Black blades 25% sharper than standard silver blades</li> </ul>									

### Olfa

### Replacement blades

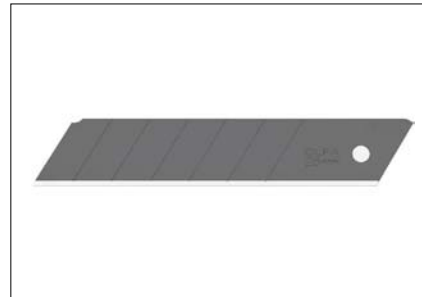

		<b>· 20 pack ·</b>							
1082209	25mm	6							
<ul style="list-style-type: none"> <li>• HBB-20B blades</li> <li>• Black blades 25% sharper than standard silver blades</li> </ul>									

### Olfa

### Replacement blades

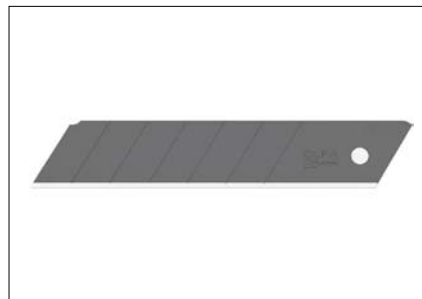

		<b>· 40 pack ·</b>							
1126905	25mm	4							
<ul style="list-style-type: none"> <li>• HBB/CP40 blades</li> <li>• Black blades 25% sharper than standard silver blades</li> </ul>									

### Replacement blades

### Olfa

### Replacement blades

		<b>· 10 pack ·</b>							
9148	9mm	6							
<ul style="list-style-type: none"> <li>• ABB-10B blades</li> <li>• Black blades 25% sharper than standard silver blades</li> </ul>									

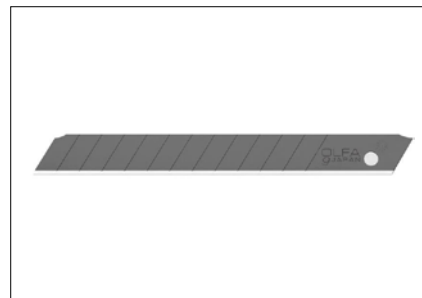

		<b>· 50 pack ·</b>							
9149	9mm	6							
<ul style="list-style-type: none"> <li>• ABB-50B blades</li> <li>• Black blades 25% sharper than standard silver blades</li> </ul>									



Item #	Size	Qty per cse	Item #	Size	Qty per cse
--------	------	-------------	--------	------	-------------

Richard

Ergo-Grip Paint Scraper 2-1/2"



· Two Sided Blade ·

04512	9" Handle	5
04514	14" Handle	5

Richard

Ergo-Grip Paint Scraper 2-1/2"



· With Knob ·

04524	14" Handle	5
-------	------------	---

Richard

Ergo-Grip Paint Scraper 2-1/2"



· Four Sided Blade ·

04564	30" Handle	5
-------	------------	---

Richard

4 Sided Replacement Blade



· Serrated Blade ·

04555	2 Pack	10
-------	--------	----



Item #	Size	Qty per cse			Item #	Size	Qty per cse		
--------	------	-------------	--	--	--------	------	-------------	--	--

### Richard

### Wood Scrapper 1"



<b>· Polypropylene Handle ·</b>									
W-10	5-7/8" Handle	5							

<b>· Replacement Blade 1" ·</b>									
CW-10-B	1 Pack	10							
W-10-B	20 Pack	1							

### Richard

### Wood Scrapper 1-3/4"



<b>· Polypropylene Handle ·</b>									
W-1-3/4"	7-5/8" Handle	5							

<b>· Replacement Blade 1-3/4" ·</b>									
CW-1 3/4-B	1 Pack	20							
W-1 3/4-B	20 Pack	1							

### Richard

### Wood Scrapper 2-1/2"



<b>· Polypropylene Handle ·</b>									
W-2 1/2"	8-1/2" Handle	5							

<b>· Replacement Blade 2-1/2" ·</b>									
CW-2 1/2-B	1 Pack	5							
W-2 1/2-B	20 Pack	1							

### Richard

### Wood Scrapper 2-1/2"



<b>· 14" Handle ·</b>									
W-14	2-1/2" Blade	5							

<b>· Replacement Blade 2-1/2" ·</b>									
CW-2 1/2-B	1 Pack	5							
W-2 1/2-B	20 Pack	1							



Item #	Size	Qty per cse	Item #	Size	Qty per cse
--------	------	-------------	--------	------	-------------

### Richard

### Wood Scraper with Knob



· 14 " Handle ·

W-14-K	2-1/2" Blade	5
--------	--------------	---

· Replacement Blade 2-1/2" ·

CW-2 1/2-B	1 Pack	5
W-2 1/2-B	20 Pack	1

### Richard

### Ergo-Grip Scraper 2"



· Carbide Blade ·

04619	2" Blade	5
-------	----------	---

· Replacement Blade 2" ·

04624	2"	5
-------	----	---

### Richard

### Ergo-Grip Scraper 3/4"



· Carbide Blade ·

04616	3/4" Blade	5
-------	------------	---

· Replacement Blade 3/4" ·

04623	3/4"	5
-------	------	---

### Richard

### Carbide Blade



· For 04616 ·

04623	3/4"	5
-------	------	---



Item #	Size	Qty per cse	STRIPPING TOOL			Item #	Size	Qty per cse
--------	------	-------------	----------------	--	--	--------	------	-------------

### Stripping Tool

### 3M

### Stripping Pads

· Stripping Tool ·								
10110NA	-	6			10111NA	Coarse Grit	8	<ul style="list-style-type: none"> <li>To be used with 3M stripping Tool 10110NA</li> </ul>
					10112NA	Medium Grit	12	
					10113NA	Fine Grit	12	

Maple Scraper			Mini Wire Brush Brass		
---------------	--	--	-----------------------	--	--

· 2" ·						· Brass ·		
130002	2"	6			HD001038	-	20	
130003	3"	6						

Dynamic			Stainless Wire Brush		
---------	--	--	----------------------	--	--

						· 6 1/2" ·		
					HD002054	-	6	<ul style="list-style-type: none"> <li>Knuckle Saver Handle</li> </ul>



Item #	Size	Qty per cse	Item #	Size	Qty per cse
--------	------	-------------	--------	------	-------------

Richard

Stainless Steel Brush



· Ergonomic Grip Handle ·					
03236	18"	5			

Richard

Carbide Steel Brush



· With Scrapper ·					
03286	5-1/4"	6			

Richard

Carbide Steel Brush



· With Overmolded Handle ·					
03282	4-3/4"	6			

Richard

3 Mini Brush Kit



· Nylon, Brass, Steel ·					
03256		10			





Item #	Size	Qty per cse			Item #	Size	Qty per cse		
--------	------	-------------	--	--	--------	------	-------------	--	--

Richard

Steel Brush With Scraper



		· High-Carbon Steel ·			
03250	1"	5			

Richard

Steel Brush With Long Handle



		· High-Carbon Steel ·			
03253	1"	5			

Richard

10" Lever Bar



		· With Scraper ·			
US-10	10"	5			

Richard

14" Lever Bar



		· With Scraper ·			
US-14	14"	5			





Item #	Size	Qty per cse	Item #	Size	Qty per cse
--------	------	-------------	--------	------	-------------

### Richard

### Sanding Block

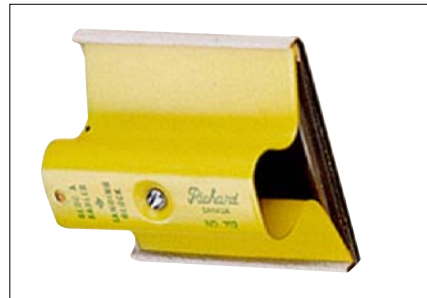

· Plastic ·		
702	4" x 3-5/8"	5

### Richard

### Aluminum Drywall Hawk



· Ergo-Grip Handle ·		
07707	13" x 13"	5

### Richard

### Steel Taping Knife



· Blue Steel ·		
RW-8-TB	8"	10
RW-10-TB	10"	10
RW-12-TB	12"	10

### Richard

### Absorbant Drop Cloth



· Leak resistant plastic back ·		
95116	10' x 12'	6



Item #	Size	Qty per cse			Item #	Size	Qty per cse		
--------	------	-------------	--	--	--------	------	-------------	--	--

## Richard

## Single Edge Razor Scraper



· Metal ·				
RS-1	-	20		

## Richard

## Retractable razor Scraper



· Plastic ·				
RS-100	-	10		

## Richard

## Retractable razor Scraper



· Metal ·				
RS-300	-	10		

## Richard

## Tampico Fiber Brush



· White Fiber ·				
95005	4-1/2" x 2"	6		
95006	13" x 3"	6		
95007	6-1/2" x 2-1/2"	6		



Item #	Size	Qty per cse			Item #	Size	Qty per cse		
--------	------	-------------	--	--	--------	------	-------------	--	--

## Richard

## Flexible Putty Knives



### · Ergo-Grip ·

RUB-1 1/4-F	1-1/4"	5
RUB-2-F	2"	5
RUB-3-F	3"	5

## Richard

## Stiff Putty Knives



### · Ergo-Grip ·

RUB-1 1/4-S	1-1/4"	5
RUB-2-S	2"	5
RUB-3-S	3"	5

## Richard

## Brass Blade Putty Knives



### · Ergo-Grip ·

RUB-151	1-1/4"	5
RUB-152	2"	5
RUB-153	3"	5

## Richard

## Joint Knife



### · Hammer Head ·

RUB-114	4"	5
RUB-115	5"	5
RUB-116	6"	5
RUB-128	8"	5
RUB-118	10"	5



Item #	Size	Qty per cse	Item #	Size	Qty per cse
--------	------	-------------	--------	------	-------------

## Richard

## 6 in 1 Ergo-Grip Tool



· Hammer Head ·

RUB-119	6 in 1	5
---------	--------	---

## Richard

## 9 in 1 Ergo-Grip Tool



· Hammer Head ·

RUB-129	9 in 1	5
---------	--------	---

## Richard

## Putty Knife



· Stiff Blade ·

H-1-S	1-3/16"	5
H-2-S	2"	5
H-3-S	3"	5
H-4-S	4"	5

## Richard

## Paint Brush Cleaner



· For Brush & Roller ·

PC-1	10
------	----



Item #	Size	Qty per cse			Item #	Size	Qty per cse		
--------	------	-------------	--	--	--------	------	-------------	--	--

### Richard

### Putty Knives



· Flexible Carbon Steel Blade ·

H-1-F	1-3/16"	5
H-2-F	2"	5
H-3-F	3"	5
H-4-F	4"	5
H-5-F	5"	5
H-6-F	6"	5

### Richard

### Flexible Putty Knives



· With Screw Bit ·

01213	3"	5
01214	4"	5
01215	5"	5

### Richard

### 3 piece Plastic Knife set



· Plastic ·

01231	3 Pcs	10
-------	-------	----

### Richard

### 4 Piece Plastic Knife set



· Plastic ·

01234	4 Pcs	10
-------	-------	----



Item #	Size	Qty per cse			Item #	Size	Qty per cse		
--------	------	-------------	--	--	--------	------	-------------	--	--

### Richard

### Taping Knife



· Semi-Stiff Plastic ·				
01130	8"	20		

### Richard

### Putty Knives



· Flexible Plastic ·				
131-F	1-9/16"	20		
133-F	3-3/16"	20		
134-F	3-15/16"	20		
135-F	5-1/8"	20		
136-F	6"	20		

### Richard

### Drywall Inside Corner Tool



· Plastic ·				
137	-	10		

### Richard

### 5 in 1 Combination Tool

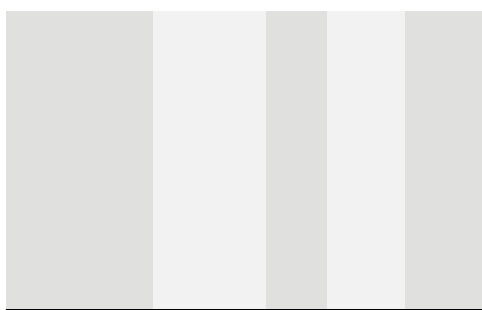

· Plastic ·				
01131	-	20		





Item #	Size	Qty per cse	<b>SANDING TOOL</b>			Item #	Size	Qty per cse
--------	------	-------------	---------------------	--	--	--------	------	-------------

### Dynamic

### Painter's Trim Guard

· 15" ·

AZ426015 - 24

### Richard

### Paint Guide

· Economy ·

R-13010 10" 20

### Richard

### Trim Guide

· Polypropylene Plastic Handle ·

DP-12 12" 10  
DP-23 23" 10



Item #	Size	Qty per cse	Item #	Size	Qty per cse
--------	------	-------------	--------	------	-------------

Richard

5 Gallons Pail Opener



· Plastic ·  
29500 6

Richard

Finishing Trowel



· Rubber Handle ·  
PC-110 10" X 4" 2

Richard

Finishing Trowel



· High amount of carbide steel ·  
35043 11-1/2" x 4-1/2" 2

Richard

Stainless Steel Trowel

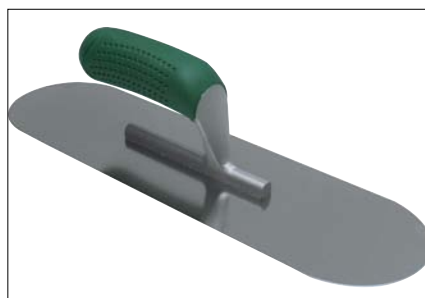

· Rubber Handle ·  
35106 14" x 4" 6



**DFM**  
INTERNATIONAL

# GROWTH STRENGTH EXCELLENCE

## SECTION 06

- Caulking
- Caulking Guns
- Glue
- Masking Tapes
- Packaging
- Plastic Wood
- Sanding Tools
- Sand  
paper
- Spackling Compound
- Steel Wools
- Tools



Item #	Size	Qty per cse
--------	------	-------------

Item #	Size	Qty per cse
--------	------	-------------

### 3M

### Scotch Blue Painter's Tape

· For Trim & Baseboards ·



2093EL-48	48mm	12
-----------	------	----

### 3M

### Painters Masking Tape

· For Painters ·



2055PCW-24	24mm	24
2055PCW-36	36mm	24
2055PCW-48	48mm	18

### 3M

### Painter's Masking Tape

· Contractor's Pack ·

· 24mm 6 Pack ·



CS-2055PCW-24CP	24mm	4
· 36mm 4 Pack ·		
CS-2055PCW-36CP	36mm	4
· 48mm 3 Pack ·		
CS-2055PCW-48CP	48mm	4

### Cantech

### Paint Pro 308 Series



· 55 m ·







308-24	24 mm	36
308-36	36 mm	24
308-48	48 mm	24



Item #	Size	Qty per cse	<b>MASKING TAPE</b>			Item #	Size	Qty per cse
--------	------	-------------	---------------------	--	--	--------	------	-------------

Duct Tape			Cantech			Masking tape		
· 55 m / 60 yd ·						· 55 m / 60 yd ·		
93-21	-	24			302-24	24mm	36	
					302-36	36mm	24	
					302-48	48mm	24	
						<ul style="list-style-type: none"> <li>• Recommended on non-coated flat surfaces</li> <li>• Can be used on ceramic, aluminum, PVC, metal.</li> </ul>		

Paint Pro 10 Days			Cantech			Paint Pro Multi-Pack		
· 55m / 60 yd ·						· 3 Pack of 50m / 60yd ·		
309-24	24mm	36			309-33	24mm		
309-36	36mm	24						
309-48	48mm	24						
<ul style="list-style-type: none"> <li>• The Professional Contractors choice.</li> <li>• The most versatile tape in terms of applications</li> <li>• Medium quick stick</li> <li>• Provides easy and clean removal within 10 days</li> </ul>								

Paint Pro 10 Days			Cantech			Paint Pro Multi-Pack		
· 3 Pack of 50m / 60yd ·						· 4 Pack of 50m / 60yd ·		
309-83	48mm	4			309-64	36mm	4	

			Cantech			General Purpose		
						· 55m / 60 yd ·		
						307-24	24mm	36
					307-36	36mm	24	
					307-48	48mm	24	
						<ul style="list-style-type: none"> <li>• Moderate aggressive adhesion</li> <li>• Recommended on porous surfaces like brick and concrete</li> <li>• Not recommended on uncoated drywall, wood floor and delicate surfaces.</li> </ul>		



Item #	Size	Qty per cse	MASKING TAPE			Item #	Size	Qty per cse
--------	------	-------------	--------------	--	--	--------	------	-------------

### Tape'n Drape

			· Tape n' Drape Refill ·					
				LA21115R	53 cm	12		

### 3M General Purpose

### 3M

### Scotch Blue Painter's Tape

· General Purpose ·						· Blue Painter's Tape ·		
2020-24A	24mm	36			2090-24E-G	24mm	24	
2020-36A	36mm	24			2090-36E-G	36mm	16	
2020-48A	48mm	24			2090-48E-G	48mm	12	

### Double-Face Carpet Tape

### Cantech

### Sheating Tape

48mm X 15m								
385-15	48mm	24			205-25	60mm x 66m	20	
						<ul style="list-style-type: none"> <li>For insulation house wrap and insulation board.</li> </ul>		





Item #	Size	Qty per cse			Item #	Size	Qty per cse		
--------	------	-------------	--	--	--------	------	-------------	--	--

### CGC Sheetrock

### Drywall Compound



· All Purpose ·

381413	2 L	6
381422	4,5 L	1
381420	12 L	1

SOLD BY CASE QUANTITY ONLY

### Drywall Tape

### IPG

### Fiberglass Drywall Tape

· White Paper ·

· Fiberglass ·

82149	76.2M	20
-------	-------	----

2072	91.4M	200
------	-------	-----

FORMERLY CODE # 2052



### DAP

### Premixed joint compound



30120	1,5 Kg	6
30070	5,5 Kg	2

### Plaster of Paris

### DAP

### Plaster of Paris

600110	2kg	6
--------	-----	---

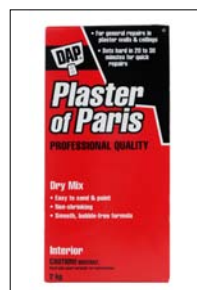

600120	10kg	1
--------	------	---





Item #	Size	Qty per cse	Item #	Size	Qty per cse
--------	------	-------------	--------	------	-------------

### Abatron

### Krack Kote Kit



· For Drywall, Plaster, Stucco, Wood ·

KRAR	Pint	8
------	------	---

### Richard

### Drywall Paper Tape



· Paper Tape ·

18450	2" X 75'	24
18451	2" X 250'	24
18452	2" X 500'	24

### Richard

### Drywall Jab Saw



· Steel Blade ·

1820	6"	10
------	----	----

### Richard

### Sanding Block



· 4" X 2-3/8" ·

B-1	-	10
-----	---	----



Item #	Size	Qty per cse			Item #	Size	Qty per cse		
--------	------	-------------	--	--	--------	------	-------------	--	--

## DAP

## Premium Wood Filler 3 en 1



· Interior / Exterior ·

74889 473 ml 4

- Wood Filler - Grain Filler - Sealer Coat
- Mix with stains or pigments for an exact match or to add a touch of colour
- Accepts all types of topcoats & finishes
- Fill natural wood grain for a smooth, tabletop finish
- Fast Drying Formula

## DAP

## Alex Flex



· Flexible Spackling ·

74870 473 ml 12

74871 946 ml 6

- Specific Application on Reoccurring Cracks
- Won't Shrink or Crack
- Sandable & Paintable
- Eliminate Reoccurring Cracks
- Interior / exterior

## DAP

## Fast Dry Premium Spackling



· For Large Drywall Repair ·

74890 946 ml 6

- Fast & Strong
- 8 times faster - 15 minutes Paint Ready
- One Coat, Won't Sink or Shrink
- 3 times stronger - superior impact resistance
- Interior / exterior

## DAP

## Alex Flex for Molding & Trims



· 60 years warranty ·

78542 300 ml 12

- Ideal for wood, MDF & composite molding
- Crack proof
- Maximum Flexibility & adhesion
- Paintable in 30 minutes
- Won't shine through paint
- Cured sealant is mold resistant
- Easy water cleanup
- Interior / exterior



Item #	Size	Qty per cse	<b>SPACKLING</b>			Item #	Size	Qty per cse
--------	------	-------------	------------------	--	--	--------	------	-------------

### Drywall Strong Patch

### Dynamic / Dap

### Eclipse

LF044001	4"x4"	12
LF055001	6"x6"	12
LF081004	8"x8"	12



· Wall repair patch ·		
74902	4 units 2"	12
74904	1 unit 4"	12
74906	1 unit 6"	12

- All in one, mess free
- Permanent, long lasting
- No spackling or sanding

### Fast N Final Lightweight Spackling

### Dap

### Alex Plus

23030	236ml	6
23050	473ml	6
71354	946ml	6

• Interior / Exterior



· Spackling ·		
74866	237ml	12
74868	946ml	6

### Drydex Spackling

### Dap / Shur-Stik

### Lightweight Spackling

· With Dry Time Indicator ·		
71162	236ml	6
71164	946ml	6

• Goes on pink dries white

• Interior / Exterior



7678-3-73	240ml	24
7678-3-77	950ml	12
7678-3-92	2 L	6

• Goes on pink dries out white.

### Polyfilla Instant

### Lepage

### Polyfilla Big Hole Repair

· Fast Drying Filler ·		
394026	162ml	12



394034	162ml	12
1256103	300ml	12

• Easily fills 1/2" cracks and holes in one application

• Will not crack or shrink

• Paintable & Sandable

• Interior / Exterior



Item #	Size	Qty per cse	Item #	Size	Qty per cse
--------	------	-------------	--------	------	-------------

### Abatron

### LiquidWood



• Epoxy Wood Consolidant •

LWAB60R	12 oz	22
LW2PKR	2 pint	12

### Abatron

### WoodEpoxy

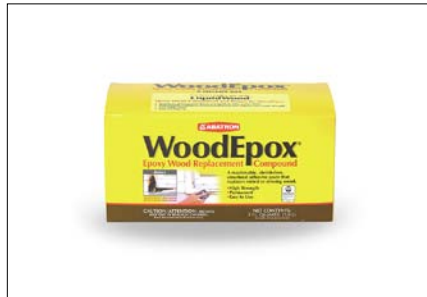

• Epoxy Wood Replacement Compound •

WEAB60R	12 oz	22
WE2QKR	2 quart	6

### Abatron

### Wood Restoration Kit



• Wood Restoration Kit •

WRK60R	24 oz	12
--------	-------	----

### Abatron

### Wood Restoration Kit



• 2 X 2L •

WR4QKR	2 X 2L	3
--------	--------	---

- Liquid Wood & Wood Epoxy Kit
- For professional



Item #	Size	Qty per cse	<b>LEPAGE GLUES</b>			Item #	Size	Qty per cse
--------	------	-------------	---------------------	--	--	--------	------	-------------

### Multi-Purpose White Glue

### LePage

### Pro Carpenter's Glue

393889	150 ml	20		
442183	400 ml	20		



530539	150 ml	20		
530538	3L	2		

### LePage

### Heavy-Duty Contact Cement

--	--	--	--	--



1504724	250ml	12		
1504619	946 ml	6		

### No More Nails

### LePage

### PL Premium 3X

2047902	177 ml	12		
FORMERLY CODE # 1675061				
2048233	266 ml	12		
FORMERLY CODE # 1654384				



1403221	295 ml	20		
---------	--------	----	--	--

### DAP

### Construction Adhesive

--	--	--	--	--



· For Subfloor ·				
74881	305 ml	12		
74882	825 ml	12		

- Maximum adhesion, stays Flexible
- Easy to apply even in cold weather
- Prevents floors from cracking
- Interior / exterior
- Quantity pricing available under certain conditions



Item #	Size	Qty per cse			WOOD FILLER	Item #	Size	Qty per cse		
--------	------	-------------	--	--	-------------	--------	------	-------------	--	--

### DAP

### Wood Pro-X



· Drydex Technology ·				
74285	156g	8		
74287	453g	12		

### Wood Pro

### DAP

### Wood Pro

· Natural ·				
74294	85g	6		
74283	453g	12		
74284	907g	6		



· Wood Filler 170g ·				
74288	Natural	6		
74289	Walnut	6		
74290	Red Oak	6		
74291	Golden Oak	6		
74293	White	6		

### Lepage Wood Filler

### Lepage

### Plastic Wood

462071	162ml	12		
462072	225ml	12		
462073	500ml	12		

• Interior / Exterior



1104773	473ml	12		
1105354	956ml	6		

### Tinted Wood Filler



· 90ml ·				
442193	White	12		
442194	Red Oak	12		
393934	Natural	12		
393935	Light Oak	12		
393936	Teak	12		
393937	Walnut	12		
393938	Mahogany	12		



Item #	Size	Qty per cse	WALL REPAIR			Item #	Size	Qty per cse
--------	------	-------------	-------------	--	--	--------	------	-------------

### DAP

### Window Glazing



· White ·		
71151	237ml	12
71112	946ml	6
71090	3,78L	2

· Tube ·		
70980	tube-300ml	12

### Dyna Patch



· 236 ml ·		
JE085001	12	

· 473 ml ·		
JE085002	6	

· 860 ml ·		
JE085003	6	

### DAP

### All Purpose Stucco Patch



60584	946ml	6
-------	-------	---

### Quick Plug<sup>MD</sup> Hydraulic Cement

### DAP

### Concrete Patch

10060	1,25 kg	6
<ul style="list-style-type: none"> <li>• Stops &amp; seals leaks in concrete &amp; masonry</li> <li>• Creates watertight seal in 3-5 minutes</li> </ul>		



Ready Mixed		
17100	946ml	6





Item #	Size	Qty per cse	<b>CAULKING</b>			Item #	Size	Qty per cse
--------	------	-------------	-----------------	--	--	--------	------	-------------

### All Purpose

### DAP Silicone

### Kitchen and Bath

· 300ml ·						· 300ml ·		
73461	White	12			73444	Clear	12	
73473	Clear	12			73446	White	12	

### Alex Plus Latex Caulking

### DAP

### Alex Fast Dry Caulking

· Alex Plus Clear ·								
74252	300ml	12			78425	300ml	12	

### DAP

### Alex Plus Latex Caulking

						· Alex Plus 40 yr ·		
								
				74225	162 ml	15		

### Alex Contractor Pack

### DAP

### Alex Plus Contractor Pack

12 Pack						12 pack		
73631	300 ml	12			74275-12	300 ml	12	
					<ul style="list-style-type: none"> <li>• 40 years</li> <li>• White</li> </ul>			





Item #	Size	Qty per cse			Item #	Size	Qty per cse		
--------	------	-------------	--	--	--------	------	-------------	--	--

### Dripless Caulking Gun

### Dap

### Pro Caulk Tool

· Professional Dripless Gun ·

· 8 piece Kit ·

FZOSH200	-	12		
----------	---	----	--	--



74875	Ens	12		
<ul style="list-style-type: none"> <li>includes:           <ul style="list-style-type: none"> <li>- 1 Caulk removal tool</li> <li>- 3 Sealing Tools</li> <li>- 3 Caulk Saver Caps</li> <li>- 1 Extended Reach Nozzle</li> </ul> </li> </ul>				

### Calfeutrant ProGun Plus

### Tower

### Calfeutrant ProGun

· White ·

· Whiter ·

12820	300 ml	12		
<ul style="list-style-type: none"> <li>50 years</li> </ul>				



12830	300 ml	12		
<ul style="list-style-type: none"> <li>45 years</li> </ul>				

### DAP

### Fire Stop

--	--	--	--	--



· Fire-Rated Silicone Sealant ·				
CS-71064	300ml	12		

### Blockade

### DAP / GH

### Acoustical Sealant

· Intumescent Sealant ·

· Grey ·

CS-74058	300ml	12		
----------	-------	----	--	--

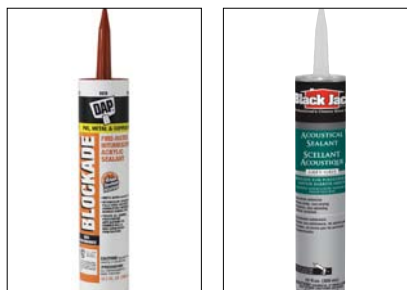

2210-7-64	300ml	24		
2210-7-84	825ml	12		





Item #	Size	Qty per cse	<b>SANDING</b>			Item #	Size	Qty per cse
--------	------	-------------	----------------	--	--	--------	------	-------------

### Sanding Sponge Bulk

### Sia / Dynamic

### Dynamic Sanding Sponge

**3-3/4" X 2-3/4"**

0070.0237.01	Med / Fine	250
--------------	------------	-----

FORMERLY CODE # 344710



**· Small Sanding Sponge ·**

AG562601	Med/Fine	12
AG582602	Med/Coarse	12

**· Dual Sanding Sponge ·**

AG662603	Med/Fine	24
AG662605	Med/Coarse	24

### Norton Sanding Sponge

### Sia Flex Pad Sponge 2 pk

NOREP00941	Med/Fin	24
------------	---------	----



**· 4 1/2" x 5 1/2" ·**

CS-S2951-080	80	10
CS-S2951-100	100	10
CS-S2951-150	150	10
CS-S2951-180	180	10

### Dynamic

### Extra Long Sanding Sponge

### Sia

AG692622	Med/Fine	10
----------	----------	----



57443	-	50
-------	---	----

### Norton

### Norton Steel Wool

--	--	--



**· Paquet de 12 ·**

07660768112	0000	6
07660768113	000	6
07660768114	00	6
07660768115	0	6
07660768116	1	6
07660768117	2	6
07660768118	3	6
07660768335	4	6



Item #	Size	Qty per cse	<b>SANDPAPER</b>			Item #	Size	Qty per cse
--------	------	-------------	------------------	--	--	--------	------	-------------

### Drywall Sanding Screen

### Sia

### Drywall Sandpaper 25 PK

• 4 3/16" x 11" •

• 4 3/16" x 11" •

S7000-080	80	50		
S7000-100	100	50		
S7000-120	120	50		
S7000-150	150	50		
S7000-220	220	50		

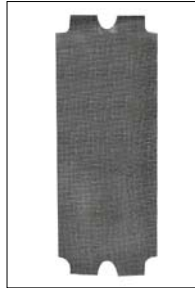

S1786-080	80	25		
S1786-100	100	25		
S1786-120	120	25		
S1786-150	150	25		

### Sia

### Siarex Cut Sandpaper

• 4 3/16" x 11" •

--	--	--	--	--

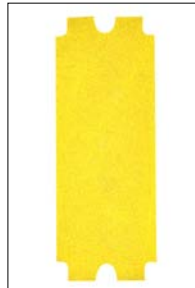

S1960-080CUT	80	100		
S1960-100CUT	100	100		
S1960-120CUT	120	100		
S1960-150CUT	150	100		
S1960-180CUT	180	100		
S1960-220CUT	220	100		

- Must be bought in multiple of 100 units



Item #	Size	Qty per cse	<b>SANDPAPER</b>			Item #	Size	Qty per cse
--------	------	-------------	------------------	--	--	--------	------	-------------

### Sandpaper Sheets

### Siarex

### Sandpaper Sheets

· 9"x11" ·				· 9"x11" ·		
S1960-040	40	25		S1960-180	180	100
S1960-060	60	50	S1960-220	220	100	
S1960-080	80	50	S1960-240	240	100	
S1960-100	100	50	S1960-280	280	100	
S1960-120	120	50	S1960-320	320	100	
S1960-150	150	50	S1960-400	400	100	

• Vendu en paquet de 50 seulement

• Vendu en paquet de 100 seulement

### Sia

### Emery Cloth 9"x 11"

· Coarse ·				· Medium ·		
S2680-060	60	50		S2680-080	80	50
· Fine ·			S2680-120	120	50	

• Must be bought in multiple of 50 units

### Dynamic Sanding Sponge

### With UPC

· 4"x 2 3/4" ·			
AG002600	Med/Fin	24	

• Bulk with UPC Code  
• Display box when bought by the case

### Full Circle

### Sanding Sponge

5" X 3" x 1" Angular			
A2-F100	Fine	100	
A2-M100	Medium	100	







Item #	Size	Qty per cse	MASKING TOOL	Item #	Size	Qty per cse
--------	------	-------------	--------------	--------	------	-------------

### Economy Hand Masker

3m

### Pro Hand Masker

· DIY ·

· Professional ·

M1000-SBN - 4

M3000 - 4

- Masking paper and masking tape dispenser
- The blade can not be replaced on this tool

- Blade not included
- Compatible blades: PB12 - 7100200124



### Masking Paper

### Trimaco

· Contractor Grade ·



12903	3"	12
12906	6"	12
12909	9"	12
12912	12"	12
12915	15"	12
12918	18"	12

3m

### Pro Hand Masker

· Blade ·

PB12 12"



### Replacement Pad

### Full Circle

### Mesh Abrasive for Radius

For Dustless System

5 Pack

PERF-FOAM - 24

MESH-SD150-5	Gr 150	5
MESH-SD180-5	GR 180	5
MESH-SD220-5	GR 220	5







Item #	Size	Qty per cse	FULL CIRCLE			Item #	Size	Qty per cse
--------	------	-------------	-------------	--	--	--------	------	-------------

### Drywall Sanding Tool

### Radius 360°

### Radius Sandpaper

TT0360	-	3
<ul style="list-style-type: none"> <li>To be used with extension pole</li> </ul>		

#### · Replacement Foam Pads ·

RP-STD	Standard	1
--------	----------	---



SD060-5	GR 060	5
SD080-5	GR 080	5
SD100-5	GR 100	5
SD120-5	GR 120	5
SD150-5	GR 150	5
SD180-5	GR 180	5
SD220-5	GR 220	5
SD240-5	GR 240	5

### Full Circle

### Sanding System



		<b>Professional</b>
FCI-DUSTLESS		1
<ul style="list-style-type: none"> <li>Includes:           <ul style="list-style-type: none"> <li>1 Radius 360</li> <li>1 Flex Air</li> <li>1 Flexible Hose</li> <li>1 Lightweight pole</li> <li>1 Sandpaper samples</li> </ul> </li> </ul>		

### Full Circle

### Flex Air



		<b>10 Pack</b>
FLEX AIR-150	GR 150	48
FLEX AIR-180	GR 180	48
FLEX AIR-220	GR 220	48

### Flex Edge 2

### Full Circle

### Flex Edge

		<b>Sanding tool</b>
FLEX2		3

#### Sand Paper 10 Pack

FLEX2-100	GR 100	10
FLEX2-120	GR 120	10
FLEX2-150	GR 150	10
FLEX2-220	GR 220	10



<b>· Sandpaper 10 PK - 3 3/4" x 8 1/2" ·</b>		
FE100	100	40
FE220	220	40

#### · Replacement Pad ·

FE-PP	HD	24
-------	----	----



Item #	Size	Qty per cse	FULL CIRCLE			Item #	Size	Qty per cse
--------	------	-------------	-------------	--	--	--------	------	-------------

### Power Pad

### Full Circle

### R-Duster

Professional		
PWR PAD	8 1/2"	24



Washable		
R-DUSTER		24
<ul style="list-style-type: none"> <li>Wipe off dust easily</li> </ul>		

### TRIGON 180°

### Detail Sander

--	--	--

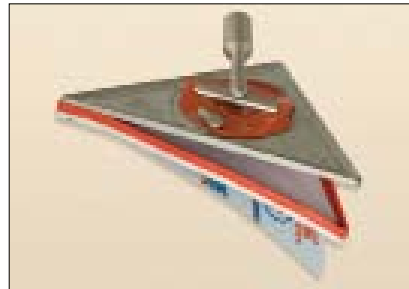

TRI180	-	24
--------	---	----

### Trigon Plate

### TRIGON 180°

### Trigon 180° Sandpaper

T180PLATE	-	24
· Replacement Pad ·		
TRI-RP	-	24



· Pqt de 5 ·		
TG100-5	100	80
TG150-5	150	80
TG220-5	220	80

### Lightweight Pole

### Accessories

### Manual Handle Adaptor

FX4	4'	6
-----	----	---



PRO-H	-	24
<ul style="list-style-type: none"> <li>Converts a pole tool to a manual tool.</li> </ul>		



Item #	Size	Qty per cse	PACKAGING			Item #	Size	Qty per cse
--------	------	-------------	-----------	--	--	--------	------	-------------

### Shrink Wrap

### Box Sealing Tape

· 14" Roll - 75mil ·			· 132 m Roll ·				
SS1416	-	4			263-00 2630072132	48mm 72mm	48 24
			• Clear				

### 3" Shrink Wrap

### 3" Roll Handle

· 19mil 3" x 1500' ·							
MP0375	-	18			GW2203	-	1

### Dymo Label

			· 2 1/8" x 2 3/4" 400 Labels/roll ·				
					ET30258-1	-	18

### Can Top Securing Clips

### Can Top Securing Clips

· For Plastic Quarts and Gallons ·			· 1000 Pack ·				
CLIP-S1	quarts & gallons	1			Clips-A-1L Clips-C-4L	1 litre 4 litres	1000 1000



**DFM**  
INTERNATIONAL

# GROWTH STRENGTH EXCELLENCE

## SECTION 07

- Accessories
- Cleaners
- Dickies Painter's Pants
- Drop Cloth
- Empty Cans / Pails
- Full Facepiece
- Gloves
- Particulate Respirator
- Protection
- Rags / Wipers
- Sponges
- T.S.P.



Item #	Size	Qty per cse	T.S.P.	Item #	Size	Qty per cse
--------	------	-------------	--------	--------	------	-------------

### SWING

### TSP



**· Resealable Package ·**

311140	400g	12
311190	900g	12
311118	1,8 kg	8

- Heavy duty cleaner
- Prepares surface for painting
- Removes wax and grease
- Biodegradable

### Swing

### Liquid TSP Spray Bottle



**· Convenient ·**

311260	625ml	6
--------	-------	---

REPLACES CODE # 12-453

### Swing

### TSP Liquid Concentrated



**· Economy ·**

311304	3,78L	4
--------	-------	---

REPLACES CODE # 12-434



Item #	Size	Qty per cse	<b>CLEANERS</b>			Item #	Size	Qty per cse
--------	------	-------------	-----------------	--	--	--------	------	-------------

### Goo Gone

### Remover

### Super Degoooper

2087	240ml	12
<ul style="list-style-type: none"> <li>Removes stickers, adhesive, crayon, gum, glue</li> </ul> <p>FORMERLY CODE # PP00GG12, 327590</p>		



320025	250ml	12
320001	1 L	12
<ul style="list-style-type: none"> <li>Removes glues, stickers, inks, tar, lipstick, polish, gum and dried latex paint</li> </ul>		

### Goof off

### Goof off

· Original ·		
FG661CAN	177ml	12
<ul style="list-style-type: none"> <li>Removes adhesive, ink, markers, scuff marks, stickers, decals, nail polish, tree sap, old latex paint</li> </ul>		



PF002416	473ml	12
----------	-------	----

### Goof off 2

--	--	--



· Low Odour ·		
PF002617	650ml	12



Item #	Size	Qty per cse	<b>CLEANERS</b>	Item #	Size	Qty per cse
--------	------	-------------	-----------------	--------	------	-------------

### Saman

### Disinfectant



**· For Hard Surfaces ·**

UAD-800	800ml	12	

### Original Krud Kutter

### Krud Kutter

### Original Krud Kutter

**Original**

287777	3,78L	1	

- Cleaner degreaser safely and easily removes food & drink stains, tape residues, marker and crayons, brake dust, pet stains, fire place soot, scuff marks, tar & wax, mildew stains, lipstick, suntan oil, soap scum, dried latex paint, glue & adhesive, smoke damage, Paint overspray, grease & oil, tree sap, oxidation, blood stains, gum, shoe polish and more



**Originale**

287785	946ml	6	

- Cleaner degreaser safely and easily removes food & drink stains, tape residues, marker and crayons, brake dust, pet stains, fire place soot, scuff marks, tar & wax, mildew stains, lipstick, suntan oil, soap scum, dried latex paint, glue & adhesive, smoke damage, Paint overspray, grease & oil, tree sap, oxidation, blood stains, gum, shoe polish and more

### Epoxy Shield

### Krud Kutter

### Graffiti Remover

**Oil Stain Remover**

287584	946ml	6	



**Spray Trigger**

287852	946ml	12	

### Circa 1850

### Bare Concrete



CS-182304	4 L	2	

- Dissolves white efflorescents salts, rust stains, most oil and grease spots.
- Prepare concrete surfaces for painting

# Concrobium



Item #	Size	Qty per cse			Item #	Size	Qty per cse		
--------	------	-------------	--	--	--------	------	-------------	--	--

## Concrobium Industrial

## Mold Control

--	--	--	--	--



· For Professional Use ·

620946	946ml	12		
--------	-------	----	--	--

## Concrobium Industrial

## Calcium Lime Rust Remover

--	--	--	--	--



· For Professional Use ·

628257	946ml	6		
--------	-------	---	--	--

## Concrobium Industrial

## Broad Spectrum Disinfectant

--	--	--	--	--



· For Professional Use ·

621004	3,78L	4		
--------	-------	---	--	--









Item #	Size	Qty per cse	<b>ACCESSORIES</b>			Item #	Size	Qty per cse
--------	------	-------------	--------------------	--	--	--------	------	-------------

### Cone Strainer

### Strainer

### 600 Microns Mesh Strainer

			<b>· Box of 100 ·</b>					
11105-100	Medium	2						
			<b>· 25 Pack ·</b>					
11511-25	for gallons	2				11513	for 5 gallons	2

### 600 Microns Mesh Strainer

### 8 pieces Painter's Rag

			<b>· 2 Pack ·</b>					
11522	for gallons	36						
11523	for 5 gallons	36				RPRW-J8P	8 mcx	12

### Premium 100% Cotton White Jersey

### Premium T-Shirt Rags

			<b>· White ·</b>					
RJTW-10	10 lbs	1						
			<b>· Off-White ·</b>					
						BXW-10C	10 lbs	1
						BXN-10C	10 lbs	1

### 100% Cotton Jersey Rag

### Fleece Rags

			<b>· Colour ·</b>					
300806	5 lbs	1						
			<b>· White ·</b>					
300805	5 lbs	1				SXC-10C	10 lbs	1
			<b>· White ·</b>					
						SXW-10C	10 lbs	1



Item #	Size	Qty per cse	<b>CHEESECLOTH</b>	Item #	Size	Qty per cse
--------	------	-------------	--------------------	--------	------	-------------

### Cheesecloth

				RCF-3	3 yds	24
--	--	--	---	-------	-------	----

### Cheesecloth

				AZ442603	3 yds x 33"	50
--	--	--	--	----------	-------------	----

### Stain Applicator

### Stain Cloth

RSAW-T2P	2 pcs	12			304	4 pcs	12
FORMERLY CODE # RSR-W4P							

### Tack Cloth

### 3 piece Stain Kit

AZ015122	18" x 36'	24			SK-3P	3 pcs	12
<ul style="list-style-type: none"> <li>Includes:           <ul style="list-style-type: none"> <li>- 1 Lint free staining cloth</li> <li>- 1 pair disposable nitril gloves</li> <li>- 1 high density foam stain applicator</li> </ul> </li> </ul>							



Item #	Size	Qty per cse				Item #	Size	Qty per cse			
--------	------	-------------	--	--	--	--------	------	-------------	--	--	--

## SPONGES

Richard

Grout Sponge



05598 · Professional ·  
5" x 8" 20

Dynamic

8" Deck Scrub Brush



KZ004590 - 24  
• For threaded poles

Marshalltown

10" Deck Scrub Brush



12985 10" x 3 1/8" 6  
• For threaded poles

PSP

10" Deck Scrub Brush



KZ004595 · 10 3/4" ·  
- 6  
• For threaded poles



Item #	Size	Qty per cse	<b>SURFACE PROTECTION</b>			Item #	Size	Qty per cse
--------	------	-------------	---------------------------	--	--	--------	------	-------------

### Nour

### Drop Cloth



· 8 oz ·		
RDC1412	14' X 12'	4
RDC320	3' X 20'	12
RDC412	4' X 12'	16
RDC812	8' X 12'	8

### Nour

### Drop Cloth 8 oz



· Leak Proof ·		
RDCPCT412	4' X 12'	20

### Trimaco

### Quick Drop Drop Cloth



· Professional ·		
90027	2' X 7'	4

### Dynamic

### Coated Drop Cloth

02040	12'x15'	10
FORMERLY CODE # KA2160D5		



KA2160D4	4'x12'	10
02035	9'x12'	10
FORMERLY CODE # KA2160D3		



Item #	Size	Qty per cse	PLASTIC SHEETS			Item #	Size	Qty per cse
--------	------	-------------	----------------	--	--	--------	------	-------------

### Trimaco

### Peel & Stick Zipper

--	--	--	--	--

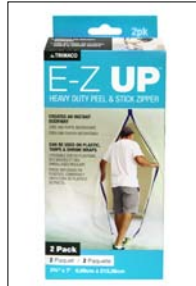

		<b>2 pack</b>	
06184/4	2-3/4" x 7'	4	

### Ralston

### Painter-Contractor Plastic Sheet

--	--	--	--	--



305-00	9' x 400'	1	
304-00	9' x 150'	12	
<ul style="list-style-type: none"> <li>• Clear</li> <li>• Contractor Grade</li> <li>• Dispenser Box</li> </ul>			

### Polyethylene Sheet

### Ralston

### Polyethylene Sheet

<b>• 10'x25' •</b>		
311-00	Light	16
312-00	Standard	9



<b>• 8'x12' •</b>		
331-00	Light	24
332-00	Standard	16
333-00	Heavy-Duty	9

### Norton

### Painter's Plastic

--	--	--	--	--



		<b>0,31 mil</b>	
07660768142	9' x 400'	-	
07660768143	12'x400'	-	



Item #	Size	Qty per cse	<b>FLOOR PROTECTION</b>			Item #	Size	Qty per cse
--------	------	-------------	-------------------------	--	--	--------	------	-------------

### Polyethylene Film

### Ralston

### Polyethylene Film

· Light ·				· Medium ·		
4114-00	102"x177'	6		4316-00	10'x150'	1
4216-00	10'x150'	1				
4219-00	10'x500'	1				
4224-00	20'x100'	1				

### FLOORSELL

### CARDBOARD

### X-BOARD

HD Surface Protection				Surface Protection		
12380	38" X 100'	1		12375	35" X 50'	12
12385	38" X 50'	1	12370	35" X 100'	9	

### Brown Rosin Paper

### Less Dye Content

						
				L3536144	36" X 144'	1

### Red Rosin Paper

### Superior Moisture barrier

				· Economy ·		
				35145 / 64	36" X 167'	64





Item #	Size	Qty per cse
--------	------	-------------

Item #	Size	Qty per cse
--------	------	-------------

### Alliance Mercantile

### Nitrile Disposable Gloves



• 4 mil - box of 100 •

34600-S	Small	10
34600-M	Medium	10
34600-L	Large	10
34600-XL	Extra-Large	10

- Economy Nitrile Gloves
- Replace serie DL101 gloves

### Alliance Mercantile

### Nitrile Disposable Gloves



• 4,5 mil - box of 100 •

34605-S	Small	10
34605-M	Medium	10
34605-L	Large	10
34605-XL	Extra-Large	10

### Alliance Mercantile

### Nitrile Disposable Gloves



• 8 mil - box of 50 •

34606-M	Medium	10
34606-L	Large	10
34606-XL	Extra-Large	10

- 8 mil
- Heavy duty

### SAS Safety

### Disposable Nitrile Gloves 7 mil



• 7 mil boîte de 100 •

66516	Small	10
-------	-------	----

- 7 mil
- Heavy Duty

# Glove



Item #	Size	Qty per cse
--------	------	-------------

Item #	Size	Qty per cse
--------	------	-------------

## Wipeco

## Nitrile Disposable Gloves

Item #	Size	Qty per cse
--------	------	-------------



**· 4 mil - Box 100 ·**

DN100-S	Small	10
DN100-M	Medium	10
DN100-L	Large	10
DN100-XL	Extra-Large	10

- Blue, powder-free

## Wipeco

## Nitrile Disposable Gloves

Item #	Size	Qty per cse
--------	------	-------------



**· 5 mil - Box of 100 ·**

DN1B5-S	Small	10
DN1B5-M	Medium	10
DN1B5-L	Large	10
DN1B5-XL	Extra-Large	10
DN1B5-XXL	XX-L	10

- Black, powder free

## Super Remover

## Super Remover Gloves

Item #	Size	Qty per cse
--------	------	-------------



4001	Medium	12
4002	Large	12
4003	X-Large	12

- Stripping Gloves
- Industrial strength
- Durable rubber covered with neoprene sleeves

## String Knit Gloves

## Painter's Gloves

11GP-L	LARGE	1
--------	-------	---

- With PVC Dots
- Must be bought by multiples of 12



R-Glove-1	Small	10
R-Glove-2	Medium	10
R-Glove-3	Large	10
R-Glove-4	Extra-Large	10
R-Glove-5	XX-Large	10

- With Polyurethane palm





Item #	Size	Qty per cse	<b>DICKIES</b>			Item #	Size	Qty per cse
--------	------	-------------	----------------	--	--	--------	------	-------------

### Painter's Pants For Women

### Painter's Pants

### Double Knee Painter's Pants

FP826-6X32	6	1			2053WH32X32	32x32	1
					2053WH34X32	34x32	1
					2053WH36X32	36x32	1
					2053WH38X32	38x32	1
					• 100% white cotton		

100% White Cotton

Painter's Pants

100% White Cotton

• 30" Leg Length •

1953P30X30	30X30	1
1953P32X30	32X30	1
1953P34X30	34X30	1
1953P36X30	36X30	1
1953P38X30	38X30	1
1953P40X30	40X30	1
1953P42X30	42X30	1



• 32" Leg Length •

1953P28X32	28x32	1
1953P30X32	30x32	1
1953P32X32	32x32	1
1953P34X32	34x32	1
1953P36X32	36x32	1
1953P38X32	38x32	1
1953P40X32	40x32	1
1953P42X32	42x32	1
1953P44X32	44x32	1

100% White Cotton

Painter's Pants

100% White Cotton

• 34" Leg length •

1953P32X34	32x34	1
1953P34X34	34x34	1
1953P36X34	36x34	1
1953P38X34	38x34	1



• 36" Leg length •

1953P34X36	34x36	1
------------	-------	---

### Painter's Bib Overall

### Dickies

### Shorts

• 100% White Cotton •

8953WH30X32	30x32	1
8953WH32X32	32x32	1
8953WH34X32	34x32	1
8953WH36X32	36x32	1
8953WH38X32	38x32	1
8953WH40X32	40x32	1
8953WH42X32	42x32	1



• 100% White Cotton •

DX401WH30	30	1
DX401WH32	32	1
DX401WH34	34	1
DX401WH36	36	1
DX401WH38	38	1
DX401WH40	40	1



Item #	Size	Qty per cse	<b>PROTECTION</b>			Item #	Size	Qty per cse
--------	------	-------------	-------------------	--	--	--------	------	-------------

## Painter's Coveralls

### · Polypropylene ·

09903	Large	12
09905	X-Large	12
09907	2X-Large	12

- With Back and Wrists Elastics
- Hood-free



### · Tyvek ·

14121	Medium	12
14122	Large	12
14123	X-Large	12
14124	2X-Large	12

- Elastic-free
- Hood-free

## Richard

## Knee Pad

--	--	--	--	--



· Foam Rubber ·		
35950	-	5

## Painter's Hood

## Wipeco / Dynamic

## Spray Sock

RPH1P	-	72
• White Cotton		



AH002175	-	12
----------	---	----

## Painter's Hood

## Trimaco

## Shoe Guards

### · Spray sock ·

09301-A	One size	36
---------	----------	----



04501/50	One size	50
• Polypropylene Shoe Guards		
• Must be bought in multiples of 50		



Item #	Size	Qty per cse	<b>HANDY PAINT PAIL</b>			Item #	Size	Qty per cse
--------	------	-------------	-------------------------	--	--	--------	------	-------------

### Handy Paint Pail

### Handy Paint Pail

### Handy Paint Pail Liners

<p>· Original ·</p> <p>92500-CT      -      12</p> <ul style="list-style-type: none"> <li>• Magnetic Brush Holder</li> <li>• Adjustable Strap</li> <li>• Paint Scraper Edge</li> <li>• Brush not included</li> </ul>			 			<p>· 6 Pack ·</p> <p>92520-CT      -      24</p> <ul style="list-style-type: none"> <li>• Liners for 92500-CT</li> </ul>		
--	--	--	--	--	--	--	--	--

### Handy Roller Cup

### Handy Paint Pail

### Handy Roller Cup Liners

<p>· Roller Cup ·</p> <p>1600-CT      -      6</p> <ul style="list-style-type: none"> <li>• For up to 6" mini roller</li> </ul>			 			<p>· 4 Pack ·</p> <p>1620-CT      -      24</p> <ul style="list-style-type: none"> <li>• Liners for 1600-CT</li> </ul>		
---	--	--	--	--	--	--	--	--

### Handy Paint Pail

### Handy Paint Cup

						<p>1500-CT      12      -</p> <ul style="list-style-type: none"> <li>• Magnet Brush Holder</li> <li>• Brush Not Included</li> </ul>		
--	--	--	---	--	--	---	--	--

### Handy Pro Pail

### Handy Paint Pail

### Cardboard Display

<p>· 946ml ·</p> <p>3200-CT      946ml      6</p>			 			<p>· Pails and Liners included ·</p> <p>CS-2000-FD      -      1</p> <ul style="list-style-type: none"> <li>• Cardboard display includes 12 pails and 24 Liners</li> </ul>		
<p>· Liner ·</p> <p>3220-CT      Doublure      12</p> <ul style="list-style-type: none"> <li>• Holds over a quart of paint or stain, accommodates up to a 6-1/2" mini-roller and up to 3" / 75mm brush</li> </ul>								



Item #	Size	Qty per cse	<b>ACCESSORIES</b>			Item #	Size	Qty per cse
--------	------	-------------	--------------------	--	--	--------	------	-------------

### Pelican Pail

### Wooster

### Pelican Liner

8619	-	6	 			8629	-	18
						· 3 Pack ·		

### Paint Bucket with Magnet

### Richard

### Paint Bucket Liner

92075	1,5 L	6	 			92094	1,5 L	10
						· 5 Pack ·		
						· Adjustable Strap ·		

### Dynamic

### Enviro Paint Trim Cup

						KK00TC25	-	6
						· Economy ·		

### Wooden Stir Stik

						4444	For gallons	1
						· Box of 500 ·		
						· For 5 Gallon Pail ·		
						1428S	For 5 gallons	250





Item #	Size	Qty per cse	<b>EMPTY CANS</b>			Item #	Size	Qty per cse
--------	------	-------------	-------------------	--	--	--------	------	-------------

1 Quart Lined			Lined Metal			Gallons Lined		
· Lined ·			 	· Lined ·				
520341	250ml	-		CR3.78GREYWEB	3,78 L	-		
371260	946ml	-		· Lined Lid ·				
· Lined Lid ·				CR3.78GREYLID	3,78 L	-		
520655	250ml	-	· Handle ·					
371261	946ml	-	11900-09	3,78 L	-			
						FORMERLY CODE # 371268 - 371269 - 371271		

Empty Spray Bottle			Plastic Pail			
· Holds 24oz / 700ml ·			 	· Lined ·		
VB24OZ	24 oz	200		544040	11 L	-
			· Plastic Lid ·			
			546280	11 L	-	

1 Quart Plastic			Plastic			
544248	946ml	-				
· Plastic Lid ·						
549106	946ml	-				

Metal			5 Gallon Pail			Plastic		
371291	18,93 L	-	 	· Lined ·				
· Metal Lid ·				371035	18,9 L	-		
371281	18,93 L	-	· Plastic Lid ·					
			371036	18,9 L	-			





Item #	Size	Qty per cse			Item #	Size	Qty per cse		
--------	------	-------------	--	--	--------	------	-------------	--	--

### Mixing Cup 473 ml

### Richard

### Mixing Cup

· Multi-Ratio ·					· Multi-Ratio ·				
92120	473 ml	12			92122	2 L	12		
									

### Mixing cup 2,5L

### Richard

### Mixing cup 946ml

· 2-1/2 quarts ·					· Multi-ratio ·				
92100	2,5L	100			92121-V	946ml	12		
									

### Dynamic

### 2 1/2 Qt Measuring Bucket

					KK061086	2,37L	1		
									





Item #	Size	Qty per cse	ACCESSORIES			Item #	Size	Qty per cse
--------	------	-------------	-------------	--	--	--------	------	-------------

3M

Aura™ Particulate Respirator



· With Valve ·		
9211	Box of 10	12

Particulate Respirator

3M

Particulate Respirator

· Box of 20 ·		
8210D20-DC	One Size	8



· With Exhalation Valve ·		
8511HB1-A-C	One Size	8

3M

Cartridge Retainer



Box of 20		
501		5

Organic Vapour Cartridge

3M

Organic Vapour Cartridge

Bulk		
6001	-	10



Individually Wrapped		
7100156937	Pqt de 2	10
FORMERLY CODE # 6001PB1-1-C		



Item #	Size	Qty per cse	FACEPIECE			Item #	Size	Qty per cse
--------	------	-------------	-----------	--	--	--------	------	-------------

### Half Facepiece

3M

### Half Facepiece

• P95 •

7512PA1-A-PS	Medium	4
7513PA1-A-C	Large	4



• Medium •

7502	-	10
------	---	----

3M

### Half Facepiece Respirator

• Quick Latch •

6502QL	Medium	10
6503QL	Large	10



3M

### Paint Respirator Supply Kit

• 1 Kit •

6023PA1-A-NA	Kit	5
--------------	-----	---

- Includes:  
1 pair of 6001 cartridges  
2 pair of 5P71 filters  
1 pair of 501 retainers



### Particulate Filter N95

3M

### Particulate Filter

• 10 Pack •

5N11	-	10
------	---	----

- For 5000 and 6000 series



2097	-	50
------	---	----

- For 5000, 6000 and 7000 series



Item #	Size	Qty per cse	<b>MIXER / SPINNER</b>			Item #	Size	Qty per cse
--------	------	-------------	------------------------	--	--	--------	------	-------------

### Paint Mixer

### Richard

### Insta-Mix Paint Mixer

· Economy ·						· 1/4" Rod ·		
703	1/4" Rod	10			55201	10" x 2-1/2"	10	
					55205	18-1/2" x 3"	10	

### Stainless Jiffy Mixer

### Nour / Simms



### Helix Easy Clean Mixer

Professional						· Polypropylene Blades ·		
ZSQJIFYHS2	1 à 2 gallons	12			HM1	1/4" for 3,78L	10	
ZSQJIFYPS1	5 à 10 gallons	12			HM5	5/16" for 18,9L	10	

### Dynamic

### Paint Mixer

### Nour

KG000603	4"x23 1/2"	12			RPM1	2 3/8" / 60mm	12	
					RPM2	3 1/4" / 30mm	12	

### Dynamic

### Super Mixer

						· Professional ·		
					DYN343	-	6	



Item #	Size	Qty per cse	Item #	Size	Qty per cse
--------	------	-------------	--------	------	-------------

### Richard

### Painter's Pyramid



· 10 Pack ·  
29510 4

### Richard

### Flexible Paint Spout



· For litre and gallons ·  
95512 50

### Crocodile Cloth

### Cleaning Cloth



· Pack of 100 ·  
6920-100-FR 15" X 10" 6

- Stays moist for longer
- Low-lint, non-woven, highly-absorbent
- Oversized thicker, stronger fabric
- Non-toxic alcohol-free formula
- Gentle on skin, hands and face
- Cleans up spray foam, caulking and adhesives
- Get paint off tools, carpet and inside cars

### HANDLE-EEZ

### Foam Pro



· Foam Handle ·  
70 Gallon of 100 1



Item #	Size	Qty per cse	ACCESSORIES			Item #	Size	Qty per cse
--------	------	-------------	-------------	--	--	--------	------	-------------

### Flexi Paint Spout

### Dynamic

### Super Lid

· For Gallons ·

KZ2140PS	for gallons	50
----------	-------------	----

- For quarts and gallons
- Gallon holder included
- Must be bought in multiples of 50



· With Spout ·

KZ00SL96	For Gallons	12
----------	-------------	----

### 5 gallon Paint Spout

### Dynamic / Richard

### Brush Extension

· For 5 Gallon Pail ·

KZ002152	-	24
----------	---	----

- For 5 Gallon Pail



· Brush Extension ·

95501	-	6
-------	---	---

### Brush and Roller Extender

### Nour / Simms

### Brush Extender

Rext	-	6
------	---	---

- For brush and roller
- Threaded to fit on extension poles



6007	-	12
------	---	----

- Metal

### Brush and Roller Spinner

### Richard / Nour

### Brush and Roller Spinner

· Brush and Roller Spinner ·

R-55500	-	5
---------	---	---



Spinner Brush Cleaner

RSPIN2	-	6
--------	---	---



Item #	Size	Qty per cse	<b>ACCESSORIES</b>	Item #	Size	Qty per cse
--------	------	-------------	--------------------	--------	------	-------------

Premium White T-Shirt 25 lbs

Wipe-It

100% Jersey Cotton Rags

BXW-25C	25 lbs	1				
---------	--------	---	--	--	--	--



		<b>White</b>		
RJTW-W4C	4 lbs	1		

Rags

Grey Sweat Shirt

--	--	--	--	--	--



		<b>Economy</b>		
SXG-10C	10 lbs	1		

Wipe-It

Fine Terry Stain Applicator

--	--	--	--	--	--



		<b>12 Pack</b>		
RSAWT 441/12P	-	1		
			• Fine Terry 4" X 4" Stain Applicator	

Can opener

Richard / Dynamic

Can opener

<b>For Quarts &amp; Gallons</b>				
C-O	-	20		



		<b>Carded</b>		
DYN260	-	12		
			FORMERLY CODE # KZ55120C	
		<b>Bulk</b>		
KZ551500	-	100		



**DFM**  
INTERNATIONAL

# GROWTH STRENGTH EXCELLENCE

## SECTION 08

- Aerosol Paint
- Circa 1850
- Foam Insulation
- Primers
- Shur-Stik
- Specialty Paint
- Stripper / Remover
- Roman
- Thinner
- Wallpaper Accessories
- Wallpaper Adhesives
- Wallpaper Stripper
- Wood Finishing Products
- Zinsser



Item #	Size	Qty per cse			Item #	Size	Qty per cse		
--------	------	-------------	--	--	--------	------	-------------	--	--

### Finitec

### Microconcrete Series



· Degreaser ·

A-21101	1 L	6
---------	-----	---

### Finitec

### MicroConcrete 400g



· New Size ·

A-50101	Carbone	6
A-50111	Anthracite	6
A-50121	Platine	6
A-50131	Aluminium	6
A-50141	Perle	6
A-50151	Ivoire	6
A-50161	Arabica	6

- Ideal for small projects
- This size allows to easily develop new colours by mixing different ratios of the premixed colours

### Finitec

### Microconcrete Series

· Microconcrete Pail 18 kg ·

A-50105	Carbon	1
A-50115	Anthracite	1
A-50125	Platinum	1
A-50135	Aluminum	1
A-50145	Pearl	1
A-50155	Ivory	1
A-50165	Arabica	1



· Microconcrete Bag 3.5 kg ·

A-50100	Carbon	4
A-50110	Anthracite	4
A-50120	Platinum	4
A-50130	Aluminum	4
A-50140	Pearl	4
A-50150	Ivory	4
A-50160	Arabica	4

### Finitec

### Microconcrete Series



· Protective Sealer 1 L ·

80250	Wet Look	6
80253	Matte Look	6

· Protective Sealer 3.64 L ·

81310	Wet Look	4
81313	Matte Look	4





Item #	Size	Qty per cse			Item #	Size	Qty per cse		
--------	------	-------------	--	--	--------	------	-------------	--	--

### Finitec

### Filling Microconcrete

--	--	--	--	--



· For Microconcrete ·				
A-50200	18 Kg	1		

### Finitec

### Flexible Trowel

--	--	--	--	--



· For Microconcrete ·				
A-50050	11" X 4-1/2"	2		
<ul style="list-style-type: none"> <li>Specifically designed for Microconcrete application</li> </ul>				





Item #	Size	Qty per cse	ACCESSORIES			Item #	Size	Qty per cse
--------	------	-------------	-------------	--	--	--------	------	-------------

### Wallpaper Tray

### Dynamic

### Foam Wallpaper Smoother

· 22" ·								
AE42WT22	-	12			AE002125	-	12	

### Single Head Paper Tiger

### Wallpaper Smoother

KZ2966SH	-	6			AE2180VS	-	10	
----------	---	---	--	---	----------	---	----	--

### Pro-555

### Roman

### Pro-880 Ultra

· Wallpaper Adhesive ·					Clear Adhesive				
011901	3,78L	4			12414	946 ml	6		
					12401	3,78L	4		
					12405	18,9L	1		
<ul style="list-style-type: none"> <li>Contractor grade</li> <li>Extreme tack</li> </ul>									

### Pro-977 Ultra Prime

### Roman

### Pro-838 Heavy Duty

Pigmented Wallpaper Primer					Clear Adhesive				
10301	3,78L	4			11314	946ml	6		
					11301	3,78L	4		
					11305	18.9L	1		



Item #	Size	Qty per cse	<b>DIVERS</b>			Item #	Size	Qty per cse
--------	------	-------------	---------------	--	--	--------	------	-------------

### Dynamic

### Pro HD Clear Adhesive



GG212040	946ml	6
GG212200	3.78 L	4
GG212400	20 L	1

### DIF Wallpaper Stripper

### Gel Formula



Spray		
710051	946ml	12

### DIF Wallpaper Stripper

### Concentrated



700035	635ml	12
--------	-------	----



Item #	Size	Qty per cse	<b>STRIPPER</b>			Item #	Size	Qty per cse
--------	------	-------------	-----------------	--	--	--------	------	-------------

### 1850

### Stripper

### Professional

· For Furniture ·

180025	250ml	12		
180050	500ml	12		
180001	1 L	12		
180004	3,78 L	2		



· Liquid ·		
CS-189720**	18,9 L	1

· Gel ·		
189904	3,78 L	2
CS-189920**	18,9L	1

\*\*DANGEROUS GOODS TRANSPORTATION GRADE

### Heavy Body Paint Remover



180650	500ml	12		
180601	1 L	12		
180604	3,78 L	2		

### Super Remover

### Super Remover Original



· Original Formula ·		
1020**	18,9 L	1

\*\*DANGEROUS GOODS TRANSPORTATION GRADE



Item #	Size	Qty per cse	SPECIALTIES			Item #	Size	Qty per cse
--------	------	-------------	-------------	--	--	--------	------	-------------

### Furniture Cleaner

### Antiquax Wax Polish

180425	250ml	12			
180450	500ml	12			



· Original Wax Polish ·

160010	100 ml	12			
--------	--------	----	--	--	--

### Nu-Lustre 57 UV Stable

### Nu-Lustre

### Nu-Lustre 55

· Exterior ·

155701	946ml	1			
155704	3,78L	1			

- UV stable, stay clear

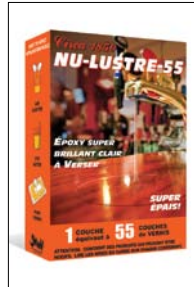

· For Horizontal Surfaces ·

155525	236ml	12			
155550	473ml	12			
155501	946ml	6			
155504	3,8 L	2			

· For Vertical Surfaces ·

CS-152701	-	6			
-----------	---	---	--	--	--

- 1 coat equals up to 55 coats of varnish
- For Craft, bar tops and more

### Klenk's

### Klenk's Lacquer Thinner

--	--	--	--	--	--



1110150	500ml	12			
---------	-------	----	--	--	--

### Epoxy Prep Kit

### Klenk's

### Klenk's Epoxy

8170	-	8			
------	---	---	--	--	--

- Prepares surfaces for Klenk's epoxy coating
- Takes off rust, oil, grim and soap scum



· White Gloss ·

815250	500ml	4			
815201	1 L	4			



Item #	Size	Qty per cse	<b>THINNER CLEANER</b>			Item #	Size	Qty per cse
--------	------	-------------	------------------------	--	--	--------	------	-------------

### Methyl Hydrate

### Gotham

### Mineral Spirits

88-1	946ml	12
88-4**	3,78L	4
88-19**	18,9L	1
ALL SIZES ARE SOLD BY THE CASE ONLY		
**DANGEROUS GOODS TRANSPORTATION GRADE		



107-4	3,78L	4
ALL SIZES ARE SOLD BY THE CASE ONLY		

### Gotham

### Acetone



110-1	946ml	12
110-4**	3,78L	4
110-19**	18,9L	1
PRICES ON DEMAND ONLY		
ALL SIZES ARE SOLD BY THE CASE ONLY		
**DANGEROUS GOODS TRANSPORTATION GRADE		

### Lacquer Thinner

### Gotham

### Xylene



133-1	946ml	10
133-4	3,78L	4
133-19**	18,9L	1
ALL SIZES ARE SOLD BY THE CASE ONLY		
**DANGEROUS GOODS TRANSPORTATION GRADE		

### Brush & Roller Cleaner

### Klenk's / Gotham

### Gun Wash

· For Oil-Based Latex & Varnishes ·

320550	500ml	12
REPLACES CODE # 53-180		
320501	1 L	12
REPLACES CODE # 53-181		



185-19**	18.9L	1
**DANGEROUS GOODS TRANSPORTATION GRADE		



Item #	Size	Qty per cse			Item #	Size	Qty per cse		
--------	------	-------------	--	--	--------	------	-------------	--	--

### Paint Scentsation

### Fragranced Paint additive



**· Odour Control ·**

102-01CA	Clean & Crisp	8
103-01CA	Fresh Air	8
105-01CA	Vanilla Bean	8
106-01CA	Citrus Squeeze	8
990-48CA	Countertop display	1

### Paint Scentsation

### Kabosh

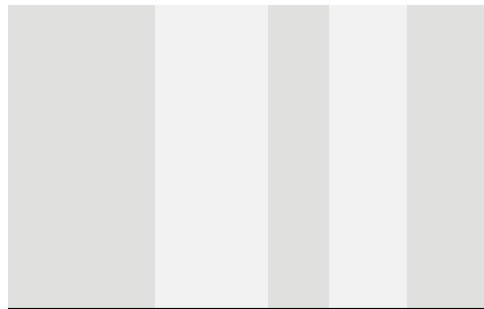

**· Paint Odour Eliminator ·**

325-01CA	1/2 oz	12
335-10CA	10 oz	4

### Flood

### Floetrol Paint Additive



2100	946ml	-
2102	3,78 L	-

- Latex paint additive to improve flow and levelling
- For latex paints, primers, stains and texture coatings
- Improves spray gun performance

### Circa

### Klenk's Japan Dryer



**For Oil Based**

902160	60ml	12
--------	------	----



Item #	Size	Qty per cse	FINISHING OIL			Item #	Size	Qty per cse
--------	------	-------------	---------------	--	--	--------	------	-------------

### Tung n' Teak Oil

### Circa 1850

### Antique Danish Oil

180750	500ml	12		
180701	1 L	12		
180704	4 L	2		



· Natural ·				
76001	1 L	6		
76004	3,78 L	2		

### Tung Oil

### Circa 1850

### Terra Nova Oil

180201	1 L	12		
--------	-----	----	--	--



210025	250ml	6		
<ul style="list-style-type: none"> <li>FDA Approved, Non-Toxic, Environmentally Friendly.</li> </ul>				

### Swing

### Double Boiled Linseed Oil

--	--	--	--	--



· Circa 1850 ·				
214701	946ml	6		
REPLACES CODE # 53-401				
214704	3,78L	4		
REPLACES CODE # 53-404				
214720	18,9L	1		
REPLACES CODE # 53-408				





Item #	Size	Qty per cse	<b>SPECIALTIES</b>			Item #	Size	Qty per cse
--------	------	-------------	--------------------	--	--	--------	------	-------------

### Black Chalkboard Paint



			· 250 ml ·					
AA670100	250ml	6						
AA670400	1 litre	6						

### Krylon

### Marking Wheel Wand 34"

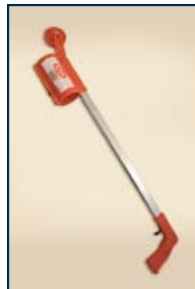

K07096	34"	1						
			• For cp150 Inversion Spray Can					

### Rust-Oleum

### Marking Wheel Wand



			For Rust-Oleum Inversion Spray					
N2393000	-	1						

### Rust-Oleum

### Striping Machine



			For Rust-Oleum Inversion					
CS-N239500	-	1						



Item #	Size	Qty per cse	AEROSOL PAINT			Item #	Size	Qty per cse
--------	------	-------------	---------------	--	--	--------	------	-------------

## Colorall Economy Grade

## Krylon Fluorescent Paint

· 283g ·			· 340g ·			
46050007	Gloss White	12		43101	Red-Orange	6
460503007	Flat White	12		<ul style="list-style-type: none"> <li>Interior / Exterior</li> </ul>		
460505007	Gloss Black	12				
460507007	Flat Black	12				
460510007	Gloss Red	12				
460525007	Gloss Green	12				
460533007	Gloss Blue	12				

## Krylon Fusion - For Plastic

			· 340g ·			
				42727	Gloss White	6
				42702	Gloss Black	6
				42725	Sunbeam Yellow	6
				42720	Red Gloss	6
				<ul style="list-style-type: none"> <li>Interior / Exterior</li> </ul>		

## Krylon High Heat Max

## Krylon

## BBQ & Stove Paint

High Heat Paint			· 340g ·			
41607	Black	6		41618	Flat Black	6
				<ul style="list-style-type: none"> <li>High Heat Paint for Stove and BBQ</li> </ul>		

## Rustoleum

## Frosted Glass

			· Semi-transparent ·			
				N1903830	Aero 312g	6



Item #	Size	Qty per cse	SPECIALTIES			Item #	Size	Qty per cse
--------	------	-------------	-------------	--	--	--------	------	-------------

### Chalkboard Paint

### Krylon

### Krylon Metallic Spray

Chalkboard Paint			Krylon			Krylon Metallic Spray		
		· 340g ·						· 340g ·
CS-40807	Black	6				41706	Gold	6
						41406	Silver	6
						42203	Copper	6
						42204	Brass	6

### Krylon Premium

### Premium Metallic 18KT Gold

Krylon Premium			Premium Metallic 18KT Gold					
								· 227g ·
						41000	18KT Gold	6





Item #	Size	Qty per cse			Item #	Size	Qty per cse		
--------	------	-------------	--	--	--------	------	-------------	--	--

### Danish Oil

### Watco

### Danish Oil

• 3,78L •

273590	Natural	2		
--------	---------	---	--	--

• -350 COV



• 946ml •

Y65141H	Golden Oak	4		
Y65341H	Black Walnut	4		
Y65541H	Light Walnut	4		
Y65741H	Natural	4		
Y65841H	Dark Walnut	4		
Y65941H	Medium Walnut	4		
334581	Briar Smoke	4		
334582	Carbone Grey	4		

### Rust Paint

### Tremclad

### Rust Paint

• 236ml •

27006X125	Aluminum	6		
27025X125	Gloss White	6		
27026X125	Gloss Black	6		
27048X125	Flat Black	6		
27061X125	Flat White	6		
27097X125	Yellow	6		



• 946ml •

254904	Aluminum	2		
254924	Gloss White	2		
254926	Gloss Black	2		
254929	Flat White	2		
254932	Flat Black	2		
254920	Brown	2		
254922	Yellow	2		

### Rust Paint

### Tremclad

### Rust Paint

• 3,78L •

27025X155	Gloss White	2		
27026X155	Gloss Black	2		
27048X155	Flat Black	2		
27061X155	Flat White	2		
27095X155	Brown	2		
27097X155	Yellow	2		



• Aerosol •

27006B522	Aluminum	6		
27025B522	Gloss White	6		
27026B522	Gloss Black	6		
27048B522	Flat Black	6		
27061B522	Flat White	6		
27095B522	Brown	6		
27097B522	Yellow	6		

### High Heat Enamel

### Tremclad / Rustoleum

### High Heat Paint

• Flat Black •

29300125	237ml	6		
254898	946ml	2		
29300522	Aero 340g	6		

• Ideal for BBQ, wood stove and motors, will resist heat up to 650° C / 1200° F



• BBQ Black •

N7778504	946ml	4		
N7778830	Aero 340g	6		

• Ideal for BBQ, wood stove and motors, will resist heat up to 650° C / 1200° F



Zinsser			Mold Blocking Primer		
Item #	Size	Qty per cse	Item #	Size	Qty per cse

## PRIMERS

### Oil Based Cover Stain

### Zinsser

### BIN Primer Sealer

200010	aerosol	6
200040	946ml	6
200050	3,78 L	2

- Blocks Cedar & Redwood Bleed
- Seals water, smoke and nicotine stain
- Stick to all surfaces without sanding
- Interior / Exterior



100010	aerosol	6
100030	473ml	6
100040	946ml	6
100050	3,78 L	2
Z00910**	18,9L	1

**\*\*DANGEROUS GOODS TRANSPORTATION GRADE**

- Shellac Based Primer Sealer
- Seals knots and sap streaks, smoke & musty odors
- Stick to all surfaces without sanding
- Fast dry, recoat in 45 minutes

### Mold Blocking Primer

### Zinsser

### Bulls Eye Odorless

**• Aerosol •**

381865	369 g	6
--------	-------	---

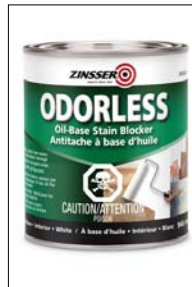

320010	340g	6
320040	946ml	6
320050	3,78 L	2

- Seals stains from water, fire & smoke damage
- Non-Yellowing, use with all top coats
- VOC compliant formula

### Bulls Eye 1-2-3

### Zinsser

### Perma White

300010	aerosol	6
300040	946ml	6
300050	3,78 L	2

- Waterbased primer sealer
- Interior / Exterior
- Stick to all surfaces without sanding
- Seals stains, graffiti and tannin bleed
- Mold & mildew resistant film
- Fast 1 hour dry time



**• 3,78 L •**

900050	Semi-Gloss	2
800050	satin	2

**• 946 ml •**

900040	semi-Gloss	6
800040	satin	6

### 4lbs Shellac

### Zinsser / GH

### Excel Waterproof

**• Clear •**

400010	aerosol	6
420030	473ml	6
420040	946ml	6
420050	3,78 L	2



**• Clear Acrylic •**

5990-000-80	3,78 L	2
5990-000-31	20 L	6

- Water-based penetrating sealer / primer
- Fast-drying, goes on white dries clear
- Can be top coated with a latex or oil-based paint
- Protects against mildew, staining, salts and acids



Item #	Size	Qty per cse	<b>SPECIALTIES</b>			Item #	Size	Qty per cse
--------	------	-------------	--------------------	--	--	--------	------	-------------

### Black Board Paint

						N1913504	877ml	4
--	--	--	---	--	--	----------	-------	---

Rust-Oleum

Magnetic Wall Primer

For Magnetic Wall Boards

						267397	887 ml	2
--	--	--	--	--	--	--------	--------	---

Rust-Oleum

Dry Erase Board Paint

White

						242673	797ml	6
--	--	--	---	--	--	--------	-------	---

Rust-Oleum

Chalk Board Paint Tint Base

Tintable to 12 Colours

						246354	887ml	4
--	--	--	---	--	--	--------	-------	---



Item #	Size	Qty per cse			Item #	Size	Qty per cse		
--------	------	-------------	--	--	--------	------	-------------	--	--

### Soudal

### Multi-Purpose Silicone



• Soudasil 300 ml •

153247	Clear	12
153248	White	12

- 100% RTV Silicone
- Mildew resistant
- Removable tip

### Soudal

### Kitchen & Bathroom Silicone



• Soudasil K & B 300 ml •

153373	Clear	12
153374	White	12

- 100% RTV Silicone
- Mildew resistant

### Soudal

### Acrylic / Latex Caulking



• Soudacryl for Painters 300 ml •

153246	White	12
--------	-------	----

- 25 years
- Paintable

### Soudal

### Soudaseal T-Rex Power SMX



• Fast Grap 290 ml •

160421	White	12
--------	-------	----

- REPLACEMENT FOR PRODUCT # 143758



Item #	Size	Qty per cse			Item #	Size	Qty per cse		
--------	------	-------------	--	--	--------	------	-------------	--	--

### Soudal

### Soudafoam Door & Window



· Minimal Expansion ·  
154141 600 ml / 588g 12

· For Foam Gun ·  
153209 750 ml / 745g 12

### Soudal

### Soudafoam Gap Fill



· Gap Fill ·  
153210 600 ml / 588g 12

· With Straw ·  
153211 300ml 12

### Soudal

### Soudafoam All Season



· From -25 to 49 Celsius ·  
158228 600 ml / 588g 12

· For Foam Gun ·  
153212 750 ml / 767g 12

### Soudal

### Gun & Foam Cleaner



· Gun & Foam Cleaner ·  
153213 500 ml / 340 g 12





Item #	Size	Qty per cse	TOUCH'N FOAM			Item #	Size	Qty per cse
--------	------	-------------	--------------	--	--	--------	------	-------------

### MaxFill

### Touch'n Foam

### HomeSeal

• Triple Expanding Sealant •

7565000127	12oz/340g	12
7565060316	16oz/454g	12
7565000128	20oz/566g	12

- 3 X Expansion to fill gaps greater than 1"
- Weather Resistant Bond seals out draft
- Class A fire Resistant
- Blocks Insects and other pest
- Interior / Exterior
- Sandable and paintable
- Saves energy



• Minimum Expanding Sealant •

7565000129	12oz/340g	12
7565062416	16oz/454g	12
7565000137	20oz/566g	12

- Ideal for smaller gaps and cracks
- Blocks drafts, pest and insects
- Cures fast, even in lower temperatures
- Water resistant / fire retardant
- Interior / exterior use
- Sandable / paintable
- All purpose formula

### Windows & Door

### Touch'n Foam

### Polyurethane Foam Sealant

• No Warp Sealant •

7565044010	12oz/340g	12
7565064416	16oz/454g	12

- Low Pressure Formula guaranteed not to warp frames or jambs
- Fills & air seals better than fiberglass
- Creates Moisture Barrier
- Meets ASTM E-84
- Class A Fire resistant
- Saves energy



• Window & Door •

7565029700	20oz/566g	12
------------	-----------	----

- Minimal expansion exerts virtually no force on frames or jambs
- Provides greater dispensing and control
- Bright White
- Meets ASTM E-84, UL-Listed
- Meets AAMA Standards 812-04 for low pressure foams
- Class A Firerated
- Easy to control Gun Foam Applicator

### Fire Break

### Touch'n Foam

### Polyurethane Foam Cleaner

• Flame Resistant Sealant •

7565040016	16oz / 454g	12
------------	-------------	----

- Meets UL 1715 UL94 V-O modified ASTM E 814
- Approved fireblock penetration sealant
- Fills & seals service penetration
- UL tested
- Class A fire Resistant



• Polyurethane •

7565028700 12oz 12  
Polyurethane foam cleaner zero VOC foam cleaner removes uncured (wet) polyurethane foam from you gun foam applicator and other tools. The adaptor nozzle may be used as a spray attachment or the can may be connected to the applicator to flush the barrel. Cleans both 1 component and 2 components uncured foam.

**NOTE: Industrial grade, not for retail sales**

### Landscape

### Touch'n Foam

### All Purpose Foam Sealant

7565040460	16 oz	12
------------	-------	----

- Bonds with rocks, stones, wood and most pond materials
- Black foam blends into shadow
- Won't Discolor like conventional foam, no painting needed
- Expands to fill gaps and voids
- Easier and less expensive than mortar
- Superior adhesion
- Fills holes in trees to seal out pests
- Use as a craft foam for artificial plants



7565028730	24 oz	12
------------	-------	----

- Seals gaps & Small openings to stop air infiltration
- Approved type V residential fireblock sealant
- Bright orange Foam simplifies inspections
- Easy to control gun foam applicator
- ICC listed (ES ESR-1926)
- Meets ASTM E-814 E-84 UL-1715
- Class A fire rated



Item #	Size	Qty per cse	TOUCH'N FOAM			Item #	Size	Qty per cse
--------	------	-------------	--------------	--	--	--------	------	-------------

## Low Temp Polyurethane Foam

## Touch'n Foam

## Mouse Shield

7565002440	24 oz	12
<ul style="list-style-type: none"> <li>• Fill expands air seals in cold temperatures</li> <li>• Cures in temperatures as low as -7° C / 20° F</li> <li>• Approved type V residential fireblock sealant</li> <li>• Meets ASTM E-814, E-84 and UL-1715</li> <li>• Class A fire rated</li> </ul>		



<b>Protection against mouse</b>		
7565041612	454g	12

<h2>Touch'n Foam</h2>	<h2>Pro System 15</h2>
-----------------------	------------------------

--	--	--



<b>· 2 Components LOW GWP ·</b>		
CS-7565002515**	-	12
<ul style="list-style-type: none"> <li>• Completely self-contained 2 component foam</li> <li>• Complete with pre-attached hoses &amp; wand applicator, The system 15 provides up to 15 board feet (theoretical) of polyurethane spray foam that expands 30 X and dries in 60 seconds</li> <li>• Pre connected hoses for fast set up</li> <li>• Contains no CFC's</li> </ul> <p>FORMERLY CODE # 7565001506 **DANGEROUS GOODS TRANSPORTATION GRADE</p>		

<h2>Pro System 200</h2>	<h2>Touch'n Foam</h2>	<h2>Pro System 600</h2>
-------------------------	-----------------------	-------------------------

<b>· Low GWP ·</b>		
CS-7565029200**	-	1
<ul style="list-style-type: none"> <li>• Low pressure 2 component polyurethane</li> <li>• Class 1 fire resistance</li> <li>• Closed cell</li> <li>• For professional use only</li> </ul> <p>**DANGEROUS GOODS TRANSPORTATION GRADE FOB, NO PREPAID SHIPMENT FOR THIS ITEM</p>		



<b>· Low GWP ·</b>		
CS-7565029600**	-	1
<ul style="list-style-type: none"> <li>• Low pressure 2 component polyurethane</li> <li>• Class 1 fire resistance</li> <li>• Closed cell</li> <li>• For professional use only</li> </ul> <p>**DANGEROUS GOODS TRANSPORTATION GRADE FOB, NO PREPAID SHIPMENT FOR THIS ITEM</p>		

<h2>DAP</h2>	<h2>Replacement Nozzle</h2>
--------------	-----------------------------

--	--	--



<b>· 5 Pack ·</b>		
7565022005	Regular Tip	6
7565022025	Fan Tip	6



Item #	Size	Qty per cse	<b>AEROSOLS</b>			Item #	Size	Qty per cse
--------	------	-------------	-----------------	--	--	--------	------	-------------

### Krylon Dual

### 2 in 1 Paint & Primer



<b>· 340g ·</b>		
CS-48800	Gloss White	6
48831	Flat Black	6

### Krylon

### Crystal Clear



<b>· Satin ·</b>		
455620007	318g	6
FORMERLY CODE # 451313		

### Krylon

### Lacquer



<b>Clear Gloss</b>		
47032	340g	6

### Krylon Rust Tough

### Krylon

### Rust Protector

<b>· Enamel ·</b>		
469000008	Gloss White	6
49204	Ruddy Brown Primer	
469038008	Grey Primer	6
469010008	Sun Yellow	6
469035008	Flat Black	6



<b>340g</b>		
469001	Gloss Black	6





Item #	Size	Qty per cse	ALLPRO	Item #	Size	Qty per cse
--------	------	-------------	--------	--------	------	-------------

### Fast Drying Enamel

### ALLPRO

### Fast Drying Enamel

· 283 G ·

· 283 G ·

11200	Chocolate Brown	6
11201	Engin Red	6
11203	Forest Green	6
11205	Tangerine	6
11206	Chrome Aluminum	6
11208	Daisy yellow	6
11207	Gold	6



11211	Gloss Black	6
11212	Gloss White	6
11213	Flat Black	6
11214	Flat White	6
11216	Navy	6
11218	Semi-Gloss Black	6

### Fast Drying Primer

### ALLPRO

### Clear Acrylic

· 283 G ·

11204	Red Oxide	6
11209	Metal Grey	6



11210	Clear	6
-------	-------	---

### Solvent Based Inverted Aerosol

### ALLPRO

### Waterbased Custom Fill

· 454 G ·

11242	Yellow	12
-------	--------	----



11245	156 G	12
-------	-------	----

### Solvent Based Custom Fill

### ALLPRO

### Cold Galvanizing 93% Zinc

11247	156 G	12
-------	-------	----



11106	454 G	6
-------	-------	---



Item #	Size	Qty per cse	<b>SPECIALTIES</b>			Item #	Size	Qty per cse
--------	------	-------------	--------------------	--	--	--------	------	-------------

### Masterchem

### Kilz Original



**Oil based primer**

10030C**	18,9L	1
----------	-------	---

- Blocks heavy stains & odours
- Blocks water & smoke stains
- Excellent adhesion, fast drying, sands easily

**\*\*DANGEROUS GOODS TRANSPORTATION GRADE**

### Rust-Oleum

### Universal Acrylic Primer



**White Water Based Primer**

278808	3,78 L	2
--------	--------	---

- Replaces product #208028

### Fixall

### Grabber Bonding Primer



**946ml**

F50700-4	White	4
----------	-------	---

**3,78 L**

F50700-1	White	4
----------	-------	---

- Water-based urethane-modified acrylic primer / sealer
- Excellent gripping power on a wide variety of surfaces

### Trillion

### Zero VOC Colorant

**1 L**

54200	(SW) White	6
54201	(SY) Yellow	6
54202	(SB) Black	6
54203	(SR) Red	6
54204	(SO) Orange	6
54205	(SI) Red Oxide	6
54206	(ST) Tan	6



**1 L**

54207	(SU) Umber	6
54208	(SG) Green	6
54209	(SP) Blue	6
54210	(SM) Magenta	6
54211	(SV) Purple	6



**DFM**  
INTERNATIONAL

# GROWTH STRENGTH EXCELLENCE

## SECTION 09

- Anti-Slip Additive
- Cabot
- Deck Cleaner
- Dex
- Fix All
- Exterior Stain
- Interior Stain
- Ready Seal
- Skid Grip
- Storm Stain
- Old Masters
- Ready Seal





Item #	Size	Qty per cse	<b>OLD MASTERS</b>	Item #	Size	Qty per cse
--------	------	-------------	--------------------	--------	------	-------------

### Gel Stain

### Gel Stain - Deep Red

· 236 ml ·

· 236 ml ·

C80116	Natural	6
C80216	Golden Oak	6
C80316	Cherry	6
C80416	Red Mahogany	6
C80516	Provincial	6
C80616	Early American	6
C80716	Dark Walnut	6
C80816	Special Walnut	6
C80916	Fruitwood	6
C81016	Pickling White	6
C81116	Dark Mahogany	6
C81216	Maple	6
C81316	Cedar	6
C81416	Spanish Oak	6
C81616	Walnut	6
C81716	Pecan	6
C81816	American Walnut	6
C81916	Aged Oak	6
C82016	Weathered Wood	6



C84116	Crimson Fire	6
C84216	Vintage Burgundy	6
C84316	Rich Mahogany	6
C84416	Espresso	6
C84516	Carbon Black	6

· 473 ml ·

C84108	Crimson Fire	4
C84208	Vintage Burgundy	4
C84308	Rich Mahogany	4
C84408	Espresso	4
C84508	Carbon Black	4

· 946 ml ·

C84104	Crimson Fire	4
C84204	Vintage Burgundy	4
C84304	Rich Mahogany	4
C84404	Espresso	4
C84504	Carbon Black	4

· 473 ml ·

C80108	Natural	4
C80208	Golden Oak	4
C80308	Cherry	4
C80408	Red Mahogany	4
C80508	Provincial	4
C80608	Early American	4
C80708	Dark Walnut	4
C80808	Special Walnut	4
C80908	Fruitwood	4
C81008	Pickling White	4
C81108	Dark Mahogany	4
C81208	Maple	4
C81308	Cedar	4
C81408	Spanish Oak	4
C81608	Walnut	4
C81708	Pecan	4
C81808	American Walnut	4
C81908	Aged Oak	4
C82008	Weathered Wood	4

### Oil-Based Polyurethane

· 363 g ·

C49410	Gloss	6
C49510	Semi-Gloss	6
C49610	Satin	6

· 236 ml ·

C49416	Gloss	6
C49516	Semi-Gloss	6
C49616	Satin	6

· 946 ml ·

C49404	Gloss	4
C49504	Semi-Gloss	4
C49604	Satin	4



C80104	Natural	4
C80204	Golden Oak	4
C80304	Cherry	4
C80404	Red Mahogany	4
C80504	Provincial	4
C80604	Early American	4
C80704	Dark Walnut	4
C80804	Special Walnut	4
C80904	Fruitwood	4
C81004	Pickling White	4
C81104	Dark Mahogany	4
C81204	Maple	4
C81304	Cedar	4
C81404	Spanish Oak	4
C81604	Walnut	4
C81704	Pecan	4
C81804	American Walnut	4
C81904	Aged Oak	4
C82004	Weathered Wood	4





Item #	Size	Qty per cse
--------	------	-------------

## OLD MASTERS

Item #	Size	Qty per cse
--------	------	-------------

### Wiping Stain

• 236 ml •



C11116	Natural	6
C11216	Golden Oak	6
C11316	Cherry	6
C11416	Red Mahogany	6
C11516	Provincial	6
C11616	Maple	6
C11716	Early American	6
C11816	Dark Mahogany	6
C11916	Cedar	6
C12016	Dark Walnut	6
C12116	Special Walnut	6
C12216	Spanish Oak	6
C12316	Fruitwood	6
C12416	Pickling White	6
C12616	Aged Oak	6
C12716	Weathered Wood	6
C12816	Natural Walnut	6
C12916	Pecan	6
C13016	American Walnut	6

### Fast Dry Stain

• Tint Base •

C60104	872 ml	4
--------	--------	---



### H<sub>2</sub>O Waterbased Stain

• 946 ml •

C76104	Tint Base	4
--------	-----------	---



### Spar-Marine Varnish

• 946ml •

C92304	Satin	4
C92404	Gloss	4
C92504	Semi-Gloss	4



• 946 ml •

C11104	Natural	4
C11204	Golden Oak	4
C11304	Cherry	4
C11404	Red Mahogany	4
C11504	Provincial	4
C11604	Maple	4
C11704	Early American	4
C11804	Dark Mahogany	4
C11904	Cedar	4
C12004	Dark Walnut	4
C12104	Special Walnut	4
C12204	Spanish Oak	4
C12304	Fruitwood	4
C12404	Pickling White	4
C12604	Aged Oak	4
C12704	Weathered Wood	4
C12804	Natural Walnut	4
C12904	Pecan	4
C13004	American Walnut	4

• 3,78 L •

C11101	Natural/Tint Base	2
--------	-------------------	---

### Wiping Stain - Deep Red

• 236 ml •

C15016	Rich Mahogany	6
C15116	Vintage Burgundy	6
C15316	Black Carbon	6

• 946 ml •

C15004	Rich Mahogany	4
C15104	Vintage Burgundy	4
C15304	Black Carbon	4



Item #	Size	Qty per cse	<b>CABOT</b>	Item #	Size	Qty per cse
--------	------	-------------	--------------	--------	------	-------------

### Cabot

### Solid Color Oil Decking Stain



• 3,78L •

7601-4	White Base	4
7606-4	Neutral Base	4
7607-4	Deep Base	4
7608-4	Medium Base	4

### Solid Color Acrylic Deck Stain

### Cabot

### Semi-Transparent Acrylic Stain

1801-4	White Base	3,78 L
1806-4	Neutral Base	3,78 L
1807-4	Deep Base	3,78 L
1808-4	Medium Base	3,78L



1306-4	Neutral Base	3,78 L
--------	--------------	--------

### Semi-Transparent

### Ready Seal

### Semi-Transparent

18,9L

505	Natural (Light Oak)	4
510	Golden Pine	4
512	Natural Cedar	4
515	Pecan	4
520	Redwood	4
525	Dark Walnut	4
530	Mahogany	4
535	Mission Brown	4
545	Burnt Hickory	4



3,78L

105	Natural (Light Oak)	4
110	Golden Pine	4
112	Natural Cedar	4
115	Pecan	4
120	Redwood	4
125	Dark Walnut	4
130	Mahogany	4
135	Mission Brown	4
145	Burnt Hickory	4

### Waterbased Waterproofer

### Cabot

### Problem Solver

1000-4	Crystal Clear	3,78 L
--------	---------------	--------

- Advanced silicone technology
- Can be applied on wood, brick and concrete



CS-8002-4	-	3,78 L
-----------	---	--------

- Wood Cleaner



Item #	Size	Qty per cse	<b>CABOT</b>			Item #	Size	Qty per cse
--------	------	-------------	--------------	--	--	--------	------	-------------

<b>Semi-transparent Deck &amp; Siding</b>			<b>Cabot</b>			<b>Semi-Solid Deck &amp; Siding</b>		
---	--	--	--------------	--	--	-------------------------------------	--	--

<b>· 3,78L ·</b>						<b>· 18,9L ·</b>		
16306-4	Neutral Base	4				CS-17406-20	Neutral Base	1
						<b>· 3,78L ·</b>		

			<b>Cabot</b>			<b>Wood Toned Deck &amp; Siding</b>		
--	--	--	--------------	--	--	-------------------------------------	--	--

						<b>· 3,78L ·</b>		
						19200-4	Natural	4
						19204-4	Heartwood	4
						19205-4	Pac Redwood	4

			<b>Cabot</b>			<b>Australian Timber Oil</b>		
--	--	--	--------------	--	--	------------------------------	--	--

						<b>· 3,78 L ·</b>		
						19400-4	Natural	4
						19458-4	Honey teak	4
						19459-4	Mohogany flame	4
						19460-4	Jarrah brown	4

			<b>Cabot</b>			<b>Deck Correct</b>		
--	--	--	--------------	--	--	---------------------	--	--

						<b>· Tint Base ·</b>		
						25200-4	3,78L	4



Item #	Size	Qty per cse	EXTERIOR PRODUCTS			Item #	Size	Qty per cse
--------	------	-------------	-------------------	--	--	--------	------	-------------

### Anti-slip additive

### Saman / California Paints

### Skid Grip

· 200g ·			· 3,78 L ·																													
UAS-000-200	200g	12			<table border="1"> <tr><td>F06511-1</td><td>White</td><td>4</td></tr> <tr><td>F06505-1</td><td>Jet</td><td>4</td></tr> <tr><td>F06510-1</td><td>Camel</td><td>4</td></tr> <tr><td>F06525-1</td><td>Crimson</td><td>4</td></tr> <tr><td>F06530-1</td><td>Cobalt</td><td>4</td></tr> <tr><td>F06555-1</td><td>Emerald</td><td>4</td></tr> <tr><td>F06565-1</td><td>Slate</td><td>4</td></tr> <tr><td>F06570-1</td><td>Smoke</td><td>4</td></tr> <tr><td>F06541-1</td><td>Neutral Base</td><td>4</td></tr> </table>	F06511-1	White	4	F06505-1	Jet	4	F06510-1	Camel	4	F06525-1	Crimson	4	F06530-1	Cobalt	4	F06555-1	Emerald	4	F06565-1	Slate	4	F06570-1	Smoke	4	F06541-1	Neutral Base	4
F06511-1	White	4																														
F06505-1	Jet	4																														
F06510-1	Camel	4																														
F06525-1	Crimson	4																														
F06530-1	Cobalt	4																														
F06555-1	Emerald	4																														
F06565-1	Slate	4																														
F06570-1	Smoke	4																														
F06541-1	Neutral Base	4																														

### Enduradeck

### Semi-Transparent Linseed Oil

· 3,78 L ·			· 3,78 L ·					
47800-1	White	4			<table border="1"> <tr><td>21595-1</td><td>Neutral Base</td><td>4</td></tr> </table>	21595-1	Neutral Base	4
21595-1	Neutral Base	4						
47891-1	Pastel Base	4						
47892-1	Medium Base	4						
47893-1	Deep Base	4						
47895-1	Neutral Base	4						
<ul style="list-style-type: none"> <li>• 15 / 5 warranty</li> <li>• Specular Gloss: 8 % @ 60° ± 2</li> <li>• With Penebond</li> </ul>								

### Brown Wood Preservative

### Circa

### Dex Outdoor Oil

· Protection Against Rot ·			· UV Protection ·								
230201	1L	6			<table border="1"> <tr><td>270701</td><td>1L</td><td>12</td></tr> <tr><td>270704</td><td>3,78L</td><td>2</td></tr> </table>	270701	1L	12	270704	3,78L	2
270701	1L	12									
270704	3,78L	2									
230204	3,78L	2									

### Preserva Wood

### Ultra Clear No Pigments

· With UV Protection ·			
40101	3,78L	4	<ul style="list-style-type: none"> <li>• Penetrating Oil</li> <li>• Protection without pigment</li> <li>• Oil based 250 VOC</li> <li>• Must be reapplied once every year</li> </ul>
			



**DFM**  
INTERNATIONAL

# GROWTH STRENGTH EXCELLENCE

## SECTION 10

- Epoxy Accessories
- Epoxy applicators
- DIY Epoxy
- Acetone Sprayers
- Industrial Epoxy



Item #	Size	Qty per cse	<b>EPOXY ACCESSORIES</b>			Item #	Size	Qty per cse
--------	------	-------------	--------------------------	--	--	--------	------	-------------

### Midwest Rake

### Spike Gunite Shoes



One Size Fits All		
46106	Pair	12

### Midwest Rake

### Spike Shoes

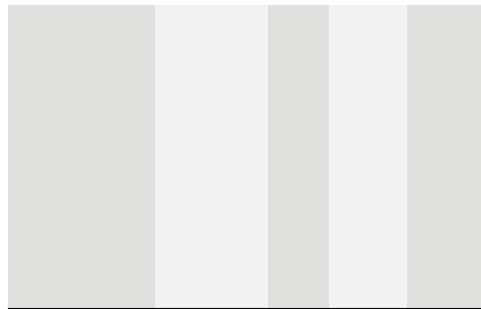

For Epoxy Application		
46171	Medium	1
46172	Large	1
46173	X-Large	1

### Nour

### Spike Gunite Shoes



One Size Fits All		
ZSQSHOES	pair	10

### Midwest Rake

### Replacement Spike



Professional		
46131	32 Pcs	1



Item #	Size	Qty per cse			Item #	Size	Qty per cse		
<b>Midwest Rake</b>					<b>Speed Squeegee 24 in.</b>				
					· Flat stiff blade ·				
					47850	24"	6		
					· Flat flexible blade ·				
					47851	24"	6		
					· 5-7 mils ·				
					47856	24"	6		
					· 8-12 mils ·				
					47859	24"	6		









Item #	Size	Qty per cse				Item #	Size	Qty per cse			
--------	------	-------------	--	--	--	--------	------	-------------	--	--	--

**Pro Woven shed**

**Midwest Rake**

**Pro-Grade Woven Roller**

48209	18"	-			
<ul style="list-style-type: none"> <li>Resist roller cover 3/8"</li> </ul>					



**For epoxy**

48208	18" x 1/4"				
-------	------------	--	--	--	--

**Midwest Rake**

**Aluminum Frame 24 in.**





**For medium use**

59050	24"	1			
-------	-----	---	--	--	--

**Midwest Rake**

**HD Aluminium frame**





60110	18"	1			
-------	-----	---	--	--	--

- 3/8" SS Axle tha

**Roller Gauge 4 mil**

**Wooster**

**Roller Gauge 22 mil**

**6 Pack**

CS-R-082	4 Mil	6			
----------	-------	---	--	--	--



**6 Pack**

CS-R-084	22 Mil	6			
----------	--------	---	--	--	--



Item #	Size	Qty per cse
--------	------	-------------

Item #	Size	Qty per cse
--------	------	-------------

### Nour

### Epoxy Squeegee



· Economy ·

ZSQTR12	12"	1
ZSQTR18	18"	1
ZSQTR22	22"	1

### Nour

### Coating Squeegee 18"



· Economy ·

ZSQ18CS	Flat blade	12
ZSQ18CS18	1/8"	1

### Nour

### Aluminium Frame Accublade





· 18" ·

ZSQ18FRBLU	18"	1
------------	-----	---

- Squeegee blade not included

### Nour

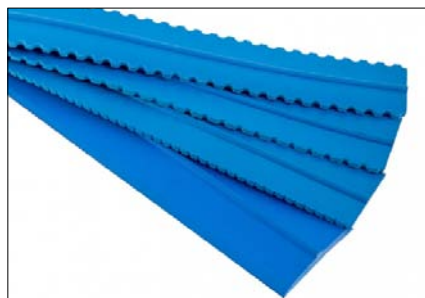
### Squeegee Accublade









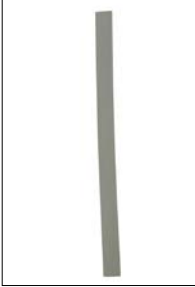

· 18" ·

ZSQ18BLU	plate	1
ZSQ18BLU10	+ / - 10 mil	1





Item #	Size	Qty per cse	EPOXY TOOLS			Item #	Size	Qty per cse
<b>EPDM Grey</b>			<b>MIDWEST RAKE</b>			<b>EPDM Grey</b>		
79210	24"	1			79230	24"	1	
• No-notch flat squeegee blade					• Squeegee blade 1/8" notch			
<b>EPDM Grey</b>			<b>MIDWEST RAKE</b>			<b>Flexible Radius Trowel</b>		
79250	24"	1			46010		1	
• Squeegee blade 3/16" notch								
<b>Cam gage rake frame tha</b>			<b>MIDWEST RAKE</b>			<b>Squeegee Frame THA</b>		
57000		1			78010	24"	1	
<b>Speed Squeegee</b>			<b>MIDWEST RAKE / Nour</b>			<b>Squeegee Clamp Frame</b>		
47150	24"	1			ZSQ24FR	24"	10	
No notch flat blade					Aluminum			



Item #	Size	Qty per cse	<b>EPOXY TOOLS</b>			Item #	Size	Qty per cse
--------	------	-------------	--------------------	--	--	--------	------	-------------

Nour

EPDM Rubber Blade



<b>Notched 1/16"</b>		
ZSQ24RB116	24"	10

Nour

EPDM Rubber Blade



<b>Flat Blade</b>		
ZSQ24RB	24"	10

Nour

EPDM Rubber Blade



<b>1/4\"</b>		
ZSQ24RB14	24"	10

Nour

EPDM Rubber Blade



<b>3/16\"</b>		
ZSQ24RB316	24"	10



Item #	Size	Qty per cse	<b>EPOXY TOOLS</b>			Item #	Size	Qty per cse
--------	------	-------------	--------------------	--	--	--------	------	-------------

Nour

EPDM Rubber Blade

--	--	--	--	--



			<b>1/8" Notched</b>	
ZSQ24RB18	24"	10		

Nour

Pro Frame

--	--	--	--	--



			<b>2 endcaps included</b>	
ZFR18Y	18"	10		

Nour

Spike Roller

--	--	--	--	--



			<b>For Epoxy</b>	
ZSQ18SPIKE	18"	10		



EPOXY			EPOXY		
Item #	Size	Qty per cse	Item #	Size	Qty per cse
<b>1/4" Flakes</b>			<b>Flakes</b>		
F6604-1/4	Primary Blue	450g	<b>1/4" Flakes</b>		
F1130-1/4	Dark Blue	450g	F6606-1/4	Neutral Grey	450g
F1820-1/4	White	450g	FB310-1/4	Orbit	450g
F1520-1/4	Milkweed	450g	FB915-1/4	Raven	450g
F1045-1/4	Beige	450g	FB706-1/4	Madras	450g
F1060-1/4	Brown	450g	<b>1/8" Flakes</b>		
F1410-1/4	Granite	450g	FB411-1/8	Domino	450g
F1415-1/4	Graphite	450g	NIGHTFALL-1/8	Nightfall	450g
F9904-1/4	Dark Grey	450g	FBGUNFLINT-1/8	Gunflint	450g
F2240-1/4	Red	450g	<b>1/16" Flakes</b>		
F2200-1/4	Yellow	450g	FB616-1/16	Wombat	450g
F2160-1/4	Orange	450g	F1140-1/16	Delarey Blue	450g
F1050-1/4	Black	450g	FB411-1/16	Domino	450g
FB411-1/4	Domino	450g	FB127-1/16	Cabin Fever	450g
F1090-1/4	Coal	450g	FB715-1/16	Nightfall	450g
FB421-1/4	Shoreline	450g	FB716-1/16	Creekbed	450g
FB127-1/4	Cabin Fever	450g	F9961-1/16	Functional Grey	450g
FB427-1/4	Stonehenge	450g	F1050-1/16	Black	450g
FB517-1/4	Outback	450g	F1090-1/16	Charbon	450g
FB616-1/4	Wombat	450g	F1410-1/16	Granite	450g
FB716-1/4	Creekbed	450g	F1820-1/16	White	450g
FB9309-1/4	Basalt Stone	450g	 <p><b>Personalised Mixed (48hrs delay)</b></p>		
F1800-1/4	Whisper Gray	450g			
FB414-1/4	Gravel	450g			
FBGUNFLINT-1/4	Gunflint	450g			
FB715-1/4	Nightfall	450g			



**DFM**  
INTERNATIONAL

# GROWTH STRENGTH EXCELLENCE

## SECTION 11

- Acetone Sprayer
- Epoxy 100% Solids
- Industrial Products
- Moisture Mitigating Primer
- Polyaspartic Floor Coating
- Products for Professional Use
- UV-Stable Urethane



Item #	Size	Qty per cse	INDUSTRIAL PRODUCTS			Item #	Size	Qty per cse
--------	------	-------------	---------------------	--	--	--------	------	-------------

### Rust-Oleum Industrial

### Cleaning & Etching Solution

--	--	--	--	--



For Concrete		
108402	3,78L	6

### Rust-Oleum Industrial

### Concrete Patching Compound

--	--	--	--	--



Turbokrete 0,15 sq. ft		
253479	2 Gallons	1
Turbokrete 0,3 sq.ft		
5494323	3,5 Gallons	1
• Grey		

### Rust-Oleum Industrial

### High Performance Concrete Patching

--	--	--	--	--



Turbokrete		
5494323	3,78L	2

### Rust-Oleum

### Instapatch

**important notice:**

Please be advised that any order including Industrial liquid merchandise from section 10 and Rust-Oleum Industrial Brands must meet a minimum of \$ 1000,00 for prepaid shipment.



Concrete Repair Kit		
276981	3,78L	1





Item #	Size	Qty per cse	CTM INDUSTRIAL			Item #	Size	Qty per cse
--------	------	-------------	----------------	--	--	--------	------	-------------

### SCI

### Thixo-5

								
						<b>Additive</b>		
			SCI-THIXO-5	1 Kg	1			

### Rainguard

### Micro-Seal Regular

								
						<b>Concentrated</b>		
			CR-0359	177 ml	12			
			CR-0360	946 ml	6			

### Rainguard

### Micro-Seal HD

								
						<b>Super Concentrated</b>		
			CR-2405	946 ml	6			

### Rainguard

### Micro-Seal HD

								
						<b>Super Concentrated</b>		
			CR-2406	177 ml / 6 oz	25			
						<ul style="list-style-type: none"> <li>Makes 1 gallon</li> </ul>		

**important notice:**

Please be advised that any order including Industrial liquid merchandise from section 10 and Rust-Oleum Industrial Brands must meet a minimum of \$ 1000,00 for prepaid shipment.



Item #	Size	Qty per cse	INSULATION			Item #	Size	Qty per cse
--------	------	-------------	------------	--	--	--------	------	-------------

### Handi Foam

### Low Pressure Polyurethane

--	--	--	--	--



· Low GWP Blowing Agent ·		
P12055C**	-	1
FORMERLY CODE # P12058C		
<ul style="list-style-type: none"> <li>• Low pressure polyurethane</li> <li>• Meets building code requirements Class 1(A)</li> <li>• COLOR WISE Temperature Warning Nozzles</li> <li>• For professional use only</li> </ul>		
**DANGEROUS GOODS TRANSPORTATION GRADE FOB NO PREPAID SHIPMENT FOR THIS ITEM		

### Handi Foam

### 2 Component Polyurethane

--	--	--	--	--



· Low GWP Blowing Agent ·		
P12056C**	-	1
FORMERLY CODE # P12059C		
<ul style="list-style-type: none"> <li>• Low pressure 2 component polyurethane</li> <li>• Meets building code requirements Class 1(A)</li> <li>• COLOR WISE Temperature Warning Nozzles</li> <li>• For professional use only</li> </ul>		
**DANGEROUS GOODS TRANSPORTATION GRADE FOB NO PREPAID SHIPMENT FOR THIS ITEM		

### Handi Foam

### Replacement Hose & Gun

--	--	--	--	--

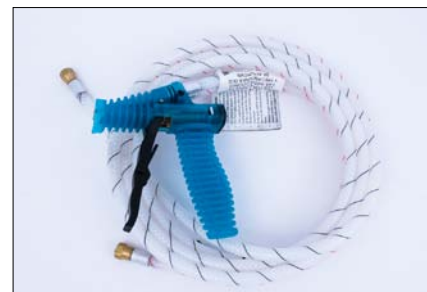

For kit 205		
F66200	9,5'	1
For kit 605		
F66210	15'	1

### Handi Foam

### Refill Nozzle

--	--	--	--	--



25 Pack		
F66117	25 Pack	9
<ul style="list-style-type: none"> <li>• Color Wise™ Temperature Warning Nozzle</li> </ul>		

**important notice:**

Please be advised that any order including Industrial liquid merchandise from section 10 and Rust-Oleum Industrial Brands must meet a minimum of \$ 1000,00 for prepaid shipment.



Item #	Size	Qty per cse	<b>INDUSTRIAL PAINT</b>			Item #	Size	Qty per cse
--------	------	-------------	-------------------------	--	--	--------	------	-------------

### Multi-Purpose Enamel

### Rust-Oleum Industrial

### Multi-Purpose Enamel

#### 12oz Aerosol

1614830	Dull Aluminum	6
1622830	Regal Blue	6
1624830	Safety Blue	6
1644830	Safety Yellow	6
1653830	Safety Orange	6
1655830	Fluo Red-Orange	6
1660830	Safety Red	6
1676830	Ultra Flat Black	6



#### 12oz Aerosol

1679830	Gloss Black	6
1680830	Gray Primer	6
1685830	Cold Galvanized	6
1686830	Universal gray	6
1690830	Flat White	6
1692830	Gloss White	6
1696830	Antique White	6
257400	Black Primer	6

### Rust-Oleum Industrial

### Cold Galvanizing Compound

#### 7000 System

CS-206194T	946ml	2
------------	-------	---



### Rust-Oleum Industrial

### Epoxy WB Floor Coating

#### Gloss 3,78L

208066	Clear	2
208072	Classic Gray	2



#### Activator

248284	Activator	2
--------	-----------	---

#### important notice:

Please be advised that any order including Industrial liquid merchandise from section 10 and Rust-Oleum Industrial Brands must meet a minimum of \$ 1000,00 for prepaid shipment.





Item #	Size	Qty per cse	<b>INDUSTRIAL PAINT</b>	Item #	Size	Qty per cse
--------	------	-------------	-------------------------	--------	------	-------------

**<250 VOC DTM Acrylic**

**Rust-Oleum Industrial**

**<250 VOC DTM Acrylic**

**5200 3,78L**

5274402	S-G Black	2
5279402	Black Gloss	2
5292402	Gloss White	2

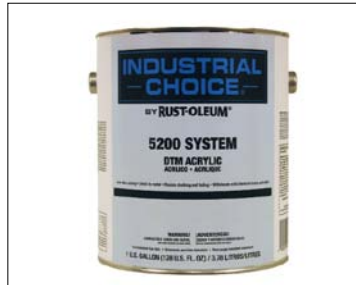

**5200 3,78L**

5217411	S-G Masstone	2
---------	--------------	---

**DTM Urethane Mastic**

**Rust-Oleum Industrial**

**DTM Urethane Mastic**

**9800 System 946ml**

9801501	Activator	
---------	-----------	--

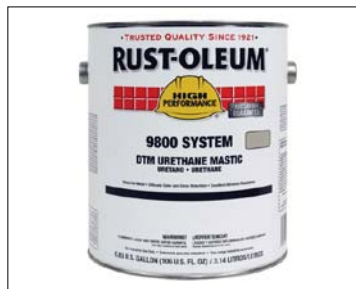

**9800 System**

9807470	Masstone Base	2
9808405	Deep Tint Base	2
9809415	Light Base	2
9879419	Black	2
9882419	Silver Gray	2
9886419	Navy Gray	2
9892419	White	2

**Rust-Preventive Enamel**

**Rust-Oleum Industrial**

**Rust-Preventive Enamel**

**V2100**

V2176838	High Heat Black	6
V2178838	Flat Black	6
V2179838	Black Gloss	6
V2182838	Gray Primer	6
V2187838	Dark Machine Gray	6
V2192838	Gloss White	6



**V2100**

CS-V2102838	Crystal Clear	6
V2124838	Safety Blue	6
V2125838	Deep Blue	6
V2143838	Safety Yellow	6

**important notice:**

Please be advised that any order including Industrial liquid merchandise from section 10 and Rust-Oleum Industrial Brands must meet a minimum of \$ 1000,00 for prepaid shipment.



Item #	Size	Qty per cse	INDUSTRIAL PAINT			Item #	Size	Qty per cse
--------	------	-------------	------------------	--	--	--------	------	-------------

### DTM Epoxy Mastic

#### 9100 System

9125402	Safety Blue
9133402	Safety Green
9144402	Safety Yellow
9165402	Regal Red
9171402	Dune Tan
9179402	Black
9182402	Gris Argent
9186402	Navy Gray
9192402	White

### Rust-Oleum Industrial



### DTM Epoxy Mastic

#### 9100 System

9101402	Standart activator
9102402	immersion activator
9104402	Fast Cure activator
9107405	Masstone
9108421	Deep Base
9109408	Light Tint Base
9115402	Aluminum
9122402	Marlin Blue

### Rust-Oleum Industrial

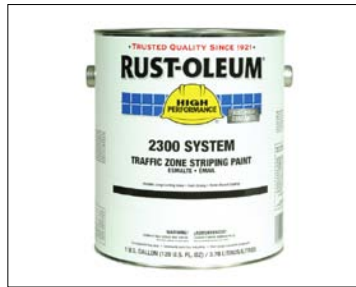

### Traffic Zone Striping Paint

#### 2300 System

2348402	Yellow	3,78L
---------	--------	-------

### Rust-Oleum Industrial



### Anti-Skid Additive

#### For Floor

200504	1 lbs	4
--------	-------	---

### Rust-Oleum



### Noxyde

#### • 18,9L •

283090	White	1
--------	-------	---

- Industrial product

#### important notice:

Please be advised that any order including Industrial liquid merchandise from section 10 and Rust-Oleum Industrial Brands must meet a minimum of \$ 1000,00 for prepaid shipment.



Item #	Size	Qty per cse	INDUSTRIAL THINNER			Item #	Size	Qty per cse
--------	------	-------------	--------------------	--	--	--------	------	-------------

### Rust-Oleum Industrial

### 633 Thinner

For Brush Application of Industrial Enamel

633402	3,78L	6
--------	-------	---



### Rust-Oleum Industrial

### 160 Thinner

V9100 System

160402	3,78L	2
--------	-------	---

- For system 9100,9300,6710, Coal Tar Epoxy



### Rust-Oleum Industrial

### 165 Thinner

V9100 Immersion System

165402	3,78L	2
--------	-------	---

- For system 9100



### Rust-Oleum Industrial

### 190 Thinner

9400 System

190402	3,78L	2
--------	-------	---

- For system 9400



**important notice:**

Please be advised that any order including Industrial liquid merchandise from section 10 and Rust-Oleum Industrial Brands must meet a minimum of \$ 1000,00 for prepaid shipment.





Item #	Size	Qty per cse	<b>INDUSTRIAL PRODUCTS</b>			Item #	Size	Qty per cse
--------	------	-------------	----------------------------	--	--	--------	------	-------------

### Rust-Oleum Industrial

### Construction Marking Paint

--	--	--	--	--



<b>Water Based 16oz</b>		
264699	Fluo red-orange	6

### Rust-Oleum Industrial

### Inverted Marking Paint

--	--	--	--	--



<b>2300 System</b>		
V2348838	Yellow	Aero

**important notice:**

Please be advised that any order including Industrial liquid merchandise from section 10 and Rust-Oleum Industrial Brands must meet a minimum of \$ 1000,00 for prepaid shipment.





**DFM**  
INTERNATIONAL

**GROWTH  
STRENGTH  
EXCELLENCE**

## SECTION 12

- Addendum

Passeport Elite Price List



**PRIVATE  
LABEL**

**PRICE LIST**

## New products

Product	SKU	Description	Qty/Box	MSRP
<b>Industrial Crack Filler - Fast Cure</b>			<b>PRICE DROP ALERT !</b>	
	PE700229	2 components 3 L Kit	1	\$108.34
<b>Industrial Crack Filler - Regular Cure</b>				
	PE700230	2 components 3 L Kit	1	\$101.67
<hr/>				
<b>Industrial Epoxy Clear</b>				
	PE700231	Clear 3 gallon Kit	1	\$208.34
	PE700232	Grey # 305 3 gallon Kit	1	\$208.34
<hr/>				
<b>Industrial Polyaspartic 2 components</b>				
	PE700235	98,5% Solids 2 gallon kit	1	\$250.00
<hr/>				
<b>Industrial Water Based Polyurethane Kit 5:1 - 1 gallon</b>				
	PE700225	Matte	6	199.97\$
	PE700226	Satin	6	199.97\$
	PE700227	Gloss	6	199.97\$

**NEW!**

## NEW PRODUCTS

Product	SKU	Description	Qty/Box	MSRP
---------	-----	-------------	---------	------

NEW!

### Universal Colourants for Epoxy and Polyaspartic - 500 ml

PE700920	White # 433	12	23.56\$
PE700921	Light Grey # 885	12	23.56\$
PE700922	Medium Grey# 663	12	23.56\$
PE700923	Shady Grey # 305	12	23.56\$
PE700924	Silver # 524	12	23.56\$
PE700925	Almond # 431	12	23.56\$
PE700926	Dark Beige # 999	12	23.56\$

### Universal Colourants for Industrial Epoxy and Polyaspartic - 1 litre



PE700236	Medium Grey # 663	6	43,52\$
PE700237	Shady Grey # 305	6	43,52\$
PE700240	Beige # 431	6	50,21\$
PE700241	Light Grey # 885	6	43,52\$

NEW!



### Metallic Colourants for Industrial Epoxy - 500 ml (not for industrial polyaspartic)

PE700935	Silver Metallic # 101	12	26.18\$
PE700936	Charcoal Metallic # 124	12	26.18\$
PE700937	Moka Metallic # 128	12	19.65\$
PE700938	Hot Chocolate Metallic # 148	12	39.28\$
PE700939	Copper Metallic # 106	12	45.83\$
PE700940	Aqua Metallic # 143	12	39.28\$
PE700941	Misty Blue Metallic # 112	12	32.73\$
PE700942	Violet Metallic # 116	12	26.18\$
PE700943	Olive Metallic # 113	12	39.28\$

### Metallic Colourants for Industrial Epoxy - 1L (not for industrial polyaspartic)



PE700243	Charcoal Metallic # 124	6	42.12\$
PE700244	Moka Metallic # 128	6	42.12\$
PE700245	Hot Chocolate Metallic # 148	6	42.12\$

Product	SKU	Description	Qty/Box	MSRP
<b>Acrylic + Series</b>				
	<b>Surface Cleaner - Acrylic + Series</b>			
	PE700200	1 L	12	\$24,16
	PE700201	3.78L	4	\$62,92
	<b>Concrete Conditioner - Acrylic + Series</b>			
	PE700203	1 L	12	\$24,16
	PE700204	3.78L	4	\$62,92
<b>Polymer Repair Ciment - Acrylic + Series</b>				
PE700205	3 kg - 2 Component Kit	1	\$33,83	
<b>Concrete Repair Coating - Acrylic + Series</b>				
PE700208	26 kg	1	\$150,46	
	<b>Textured Acrylic Coating - Acrylic + Series</b>			
	PE700210	Fine - Pale Base 9 kg	1	\$132,27
	PE700211	Fine - Medium Base 9 kg	1	\$132,27
	PE700212	Fine - Dark Base 9 kg	1	\$132,27
	PE700213	Fine - Pale 19 kg	1	\$223,80
	PE700214	Fine - Medium Base 19 kg	1	\$223,80
	PE700215	Fine - Dark Base 19 kg	1	\$223,80
<b>Water Based Acrylic Sealer - Acrylic + Series</b>				
PE700219	900 ml	12	\$32,60	
PE700220	3.7 L	4	\$84,14	
CS-PE700221	18.9 L	1	\$342,00	
<b>Solvent Based Acrylic Sealer - Acrylic + Series</b>				
PE700222	3.78 L	4	\$112,39	
PE700223	11.4 L	1	\$270,93	
CS-PE700224	18.9 L	1	\$383,07	

## Exterior Products

Product	SKU	Description	Qty/box	MSRP
<b>STEINA Solid Colour Exterior Stain</b>				
	PE700870	White Tint Base - 3.78L	4	\$89.99
	PE700871	Medium Tint Base - 3.78L	4	\$89.99
	PE700872	Deep Tint Base - 3.78L	4	\$89.99
	PE700873	Clear Tint Base - 3.78L	4	\$89.99

## STEINA Blocking Exterior Primer



PE700880	White - 3,78L	4	\$85.99
----------	---------------	---	---------

## STEINA End-Cut Sealer for Pressure Treated Wood



PE700881	Natural # 610 - 946ml	6	\$23.70
PE700882	Brown # 680 - 946ml	6	\$23.70

## Exterior Products

Product	SKU	Description	Qty/box	MSRP
<b>STEINA Exterior Penetrating Oil</b>				
	PE700850	Light Oak - 105 3.78L	4	\$88.99
	PE700851	Natural Cedar - 112 3.78L	4	\$88.99
	PE700852	Pecan - 115 3.78L	4	\$88.99
	PE700853	Redwood - 120 3.78L	4	\$88.99
	PE700854	Dark Walnut - 125 3.78L	4	\$88.99
	PE700855	Mahogany - 130 3.78L	4	\$88.99
	PE700856	Mission Brown - 135 3.78L	4	\$88.99
	PE700857	Burnt Hickory - 145 3.78L	4	\$88.99

## Exterior Oil Based Stain Semi-Transparent

	PE700841-1	Tint Base 3,52L	4	\$93.66
	PE700841-4	Tint Base 887ml	4	\$32.48





## Deck Cleaner

	PE700425	Exterior Deck Cleaner 3,78L	4	\$23.99
---	----------	--------------------------------	---	---------

## Empty Pail

	PE700132	Empty Pail 17 L	1	\$8.99
	PE700133	Lid for PE700132 17L	1	\$2.99

## Sealer for concrete

Product	SKU	Description	Qty/box	MSRP
<b>Anti-Slip Additive</b>				
	PE700367	100% Natural 200 g	12	\$8.49
<b>Anti-Slip Coating</b>				
	PE700490	Tintable White 3,78L	4	\$70.50
	PE700491	Deep Base 3,78L	4	\$70.50
<b>Sealer for concrete, Brick and Anti-Slip Coating</b>				
	PE700494	Satin finish 946ml	6	\$18.39
	PE700495	Satin finish 3,78L	2	\$36.11
	PE700496	Satin finish 18,9L	1	\$136.95
<b>Solvent-Based Sealer FOR INDUSTRIAL USE ONLY</b>				
	PE700603	Satin 10% lustre 3.78L	1	\$56.00
	PE700604	Semi-Gloss 20% lustre 3.78L	1	\$65.00
	PE700605**	Satin 10% lustre 18.9L	1	\$192.00
	PE700606**	Semi-Gloss 20% lustre 18.9L	1	\$224.00
<b>Concrete Finish for Counter and Floors</b>				
	PE700590	Concrete finish for counter and floor Chic Satin 946ml	1	\$56.49
	PE700591	Concrete finish for counter and floor Chic Satin 3,78L	1	\$192.91







\*\*DANGEROUS GOOD TRANSPORTATION GRADE

P: 450-349-2226 • 1-877-989-2226 • F: 450-349-1799 • info@passeportelite.com  
DFM International's standard terms and conditions of sale apply to this list. All prices are subject to change without notice.

PASSEPORT  
**ELITE**

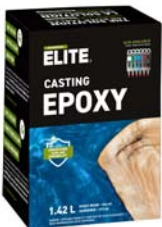

## New products

Product	SKU	Description	Qty/box	MSRP
<b>Countertop Epoxy 1,42L</b>		<b>PRICE DROP ALERT !</b>		
	PE700908	2 Part Epoxy Kit 1,42L Kit	1	\$75.00
	PE700907	4.5L Clear Base Including: - 3L Epoxy Resin - 1.5L Hardener	1	\$166.67
<hr/>				
<b>Casting Epoxy</b>				
	PE700998	1,42L Box	1	\$72.00
	PE700997	4,13L Box	1	\$178.09
	PE700996	12 Litre Kit Industrial	1	\$321.00
<hr/>				
<b>Colour Pigment for Countertop and Casting Epoxy</b>				
	PE700890	Coral #119	12	\$7.60
	PE700891	Surf # 120	12	\$7.60
	PE700892	Aruba #121	12	\$7.60
	PE700893	Indigo #122	12	\$7.60
	PE700894	Melon # 123	12	\$7.60
	PE700895	Onyx # 124	12	\$7.60

## 100% Solids Epoxy

Product	SKU	Description	Qty/box	MSRP
---------	-----	-------------	---------	------

### Patching Compound - 2 Component Epoxy



PE700905	<b>Concrete Crack Filler</b> 2 Component Epoxy	1	\$45.99
----------	---	---	---------

### All-in-One Kit - Ready-Mixed Colours

PRICE DROP ALERT !



PE700900	<b>4,5L Clear Base</b> Including : - 3L Epoxy Resin - 1.5L Hardener	1	\$135.82
----------	--	---	----------

PE700901	<b>4,5L Light Grey 388/885</b> Including : - 3L Epoxy Resin - 1.5L Hardener	1	\$135.82
----------	--	---	----------

## 100% Solids Epoxy

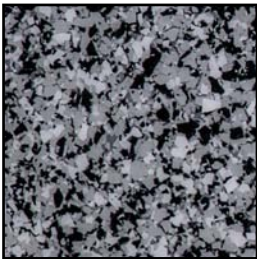
Product	SKU	Description	Qty/box	MSRP
<b>Epoxy Decorative Vinyl Flakes - 5 lb Bulk</b>				
	PE700970	Domino - 001F 5 lb	10	31,40 \$
	PE700971	Wrought Iron - 002F 5 lb	10	31,40 \$
	PE700972	River Sand - 003F 5 lb	10	31,40 \$
	PE700974	Driftwood - 005F 5 lb	10	31,40 \$
	PE700975	Cappucino - 006F 5 lb	10	31,40 \$
	PE700985	Sapphir - 016F 5 lb	10	31,40 \$

### Price by the pound (minimum of 5 lb per mix)

1 lbs (minimum of 5 lb per mix)	5	5,92 \$
---------------------------------	---	---------

Colour flake blends, regular or special orders, cannot be returned.

### Epoxy Application Toolkit

PE700906	<b>13 Piece Kit</b>	1	\$93.48
Includes:			
- 1 18" squeegee			
- 2 Lint free sleeves 9-1/2" 10mm			
- 1 Power mixer			
- 1 Pair of spike shoes			
- 2 Chip brushes			
- 2 pair of nitril gloves			
- 2 Wooden stir stick			
- 1 Plastic cage frame 9-1/2"			
- 1 Pair of end caps			



### Epoxy Finish



PE700593	<b>Gloss 940ml</b>	1	\$57.49
PE700594	<b>Satin 940ml</b>	1	\$57.49
PE700595	<b>Gloss 3,78 L</b>	1	\$198.99

## Primers and Paint

Product	SKU	Description	Qty/box	MSRP
---------	-----	-------------	---------	------

### Anti-Spatter & Easy-to-Apply Ceiling Paint



PE700157	3.78L	2	\$51.02
PE700158	18.9L	1	\$200.32

### Stain Killer Shellac Primer Sealer



PE700600	Shellac Primer 946 ml	6	\$37.79
PE700601	Shellac Primer 3.78L	2	\$119.99
PE700602	Shellac Primer 18.9L	1	\$561.70

## Wood Stain

Product	SKU	Description	Qty/box	MSRP
---------	-----	-------------	---------	------

### Stain Applicator 4" X 4"



PE700308	Stain Applicator 4" X 4" - 2 Pk	6	\$4.24
----------	---------------------------------	---	--------

### Wood Stain - Water-Based



PE700700	236ml Barn Wood - 300	6	\$14.99
PE700701	236ml Golden Oak - 301	6	\$14.99
PE700702	236ml Nutmeg - 302	6	\$14.99
PE700703	236ml Dark Walnut - 303	6	\$14.99
PE700704	236ml Natural - 304	6	\$14.99
PE700705	236ml Spanish Oak - 305	6	\$14.99
PE700706	236ml Hazelnut - 306	6	\$14.99
PE700707	236ml Antique White - 307	6	\$14.99
PE700708	236ml Cocoa - 308	6	\$14.99
PE700709	236ml Wheat - 309	6	\$14.99
PE700710	236ml Pecan - 310	6	\$14.99
PE700711	236ml Coffee - 311	6	\$14.99
PE700712	236ml Provincial - 312	6	\$14.99
PE700713	236ml Wild Olive - 313	6	\$14.99
PE700714	236ml Cinnamon - 314	6	\$14.99
PE700715	236ml Chestnut - 315	6	\$14.99
PE700716	236ml Black - 316	6	\$14.99
PE700717	236ml Gray Birch - 317	6	\$14.99
PE700718	236ml Paprika - 318	6	\$14.99
PE700719	236ml Black Walnut - 319	6	\$14.99

## Wood Stain

Product	SKU	Description	Qty/box	MSRP
<b>Wood Stain - Water-Based</b>				
	PE700730	473ml Barn Wood - 300	4	\$22.76
	PE700731	473ml Golden Oak - 301	4	\$22.76
	PE700732	473ml Nutmeg - 302	4	\$22.76
	PE700733	473ml Dark Walnut - 303	4	\$22.76
	PE700734	473ml Natural - 304	4	\$22.76
	PE700735	473ml Spanish Oak - 305	4	\$22.76
	PE700736	473ml Hazelnut - 306	4	\$22.76
	PE700737	473ml Antique White - 307	4	\$22.76
	PE700738	473ml Cocoa - 308	4	\$22.76
	PE700739	473ml Wheat - 309	4	\$22.76
	PE700740	473ml Pecan - 310	4	\$22.76
	PE700741	473ml Coffee - 311	4	\$22.76
	PE700742	473ml Provincial - 312	4	\$22.76
	PE700743	473ml Wild Olive - 313	4	\$22.76
	PE700744	473ml Cinnamon - 314	4	\$22.76
	PE700745	473ml Chestnut - 315	4	\$22.76
	PE700746	473ml Black - 316	4	\$22.76
	PE700747	473ml Gray Birch - 317	4	\$22.76
	PE700748	473ml Paprika - 318	4	\$22.76
	PE700749	473ml Black Walnut - 319	4	\$22.76

## Wood Stain

Product	SKU	Description	Qty/box	MSRP
<b>Wood Stain - Water-Based</b>				
	PE700760	940ml Barn Wood - 300	6	\$38.49
	PE700761	940ml Golden Oak - 301	6	\$38.49
	PE700762	940ml Nutmeg - 302	6	\$38.49
	PE700763	940ml Dark Walnut - 303	6	\$38.49
	PE700764	940ml Natural - 304	6	\$38.49
	PE700765	940ml Spanish Oak - 305	6	\$38.49
	PE700766	940ml Hazelnut - 306	6	\$38.49
	PE700767	940ml Antique White - 307	6	\$38.49
	PE700768	940ml Cocoa - 308	6	\$38.49
	PE700769	940ml Wheat - 309	6	\$38.49
	PE700770	940ml Pecan - 310	6	\$38.49
	PE700771	940ml Coffee - 311	6	\$38.49
	PE700772	940ml Provincial - 312	6	\$38.49
	PE700773	940ml Wild Olive - 313	6	\$38.49
	PE700774	940ml Cinnamon - 314	6	\$38.49
	PE700775	940ml Chestnut - 315	6	\$38.49
	PE700776	940ml Black - 316	6	\$38.49
	PE700777	940ml Gray Birch - 317	6	\$38.49
	PE700778	940ml Paprika - 318	6	\$38.49
	PE700779	940ml Black Walnut - 319	6	\$38.49
	PE700780	800ml Tint Base	6	To be determined by the retailer



## Wood Stain

Product	SKU	Description	Qty/box	MSRP
<b>Wood Stain - Water-Based</b>				
	PE700790	3.78L Barn Wood - 300	2	\$147.54
	PE700791	3.78L Golden Oak - 301	2	\$147.54
	PE700792	3.78L Nutmeg - 302	2	\$147.54
	PE700793	3.78L Dark Walnut - 303	2	\$147.54
	PE700794	3.78L Natural - 304	2	\$147.54
	PE700795	3.78L Spanish Oak - 305	2	\$147.54
	PE700796	3.78L Hazelnut - 306	2	\$147.54
	PE700797	3.78L Antique White - 307	2	\$147.54
	PE700798	3.78L Cocoa - 308	2	\$147.54
	PE700799	3.78L Wheat - 309	2	\$147.54
	PE700800	3.78L Pecan - 310	2	\$147.54
	PE700801	3.78L Coffee - 311	2	\$147.54
	PE700802	3.78L Provincial - 312	2	\$147.54
	PE700803	3.78L Wild Olive - 313	2	\$147.54
	PE700804	3.78L Cinnamon - 314	2	\$147.54
	PE700805	3.78L Chestnut - 315	2	\$147.54
	PE700806	3.78L Black - 316	2	\$147.54
	PE700807	3.78L Gray Birch - 317	2	\$147.54
	PE700808	3.78L Paprika - 318	2	\$147.54
	PE700809	3.78L Black Walnut - 319	2	\$147.54
PE700810	3.78L Tint Base	2	To be determined by the retailer	



Product	SKU	Description	Qty/box	MSRP
---------	-----	-------------	---------	------

## Floor Varnish - Water-Based



PE700375	472ml Mate	12	\$23.00
PE700376	472ml Satin	12	\$23.00
PE700377	472ml Semi-gloss	12	\$23.00
PE700378	472ml Gloss	12	\$23.00
PE700370	946ml Mate	6	\$31.12
PE700371	946ml Satin	6	\$31.12
PE700372	946ml Semi-gloss	6	\$31.12
PE700373	946ml Gloss	6	\$31.12
PE700380	3.78L Mate	2	\$111.50
PE700381	3.78L Satin	2	\$111.50
PE700382	3.78L Semi-gloss	2	\$111.50
PE700383	3.78L Gloss	2	\$111.50
PE700385	18.9L Mate	1	\$463.25
PE700386	18.9L Satin	1	\$463.25
PE700387	18.9L Semi-gloss	1	\$463.25
PE700388	18.9L Gloss	1	\$463.25

Product	SKU	Description	Qty/box	MSRP
<b>Floor Varnish - Oil-Based Hybrid</b>				
	PE700570	946ml Mate	6	\$31.42
	PE700571	946ml Satin	6	\$31.42
	PE700572	946ml Semi-gloss	6	\$31.42
	PE700573	946ml Gloss	6	\$31.42
	PE700580	3.78L Mate	2	\$116.40
	PE700581	3.78L Satin	2	\$116.40
	PE700582	3.78L Semi-gloss	2	\$116.40
	PE700583	3.78L Gloss	2	\$116.40
	CS-PE700585	18.9L Mate	1	\$480.55
	CS-PE700586	18.9L Satin	1	\$480.55
	CS-PE700587	18.9L Semi-gloss	1	\$480.55
	CS-PE700588	18.9L Gloss	1	\$480.55

## High-Performance Floor Varnish

Product	SKU	Description	Qty/box	MSRP
---------	-----	-------------	---------	------

### High-Performance Floor Varnish - Water-Based



PE700470	3.78L Mate	2	\$150.23
PE700471	3.78L Satin	2	\$150.23
PE700472	3.78L Semi-gloss	2	\$150.23
PE700473	3.78L Gloss	2	\$150.23

### A.T. Catalyst



PE700469	118ml	12	\$19.84
----------	-------	----	---------

## Water-Based Uralkyd Varnish

Product	SKU	Description	Qty/box	MSRP
---------	-----	-------------	---------	------

### Water-Based Uralkyd Varnish



PE700556	940ml Satin	6	\$48.32
----------	-------------	---	---------

PE700557	940ml Semi-Gloss	6	\$48.32
----------	------------------	---	---------

PE700560	3,78L Satin	2	\$152.79
----------	-------------	---	----------

PE700561	3,78L Semi-Gloss	2	\$152.79
----------	------------------	---	----------

### Butcher Block Oil & Conditioner



PE700844	500ml	12	\$18.02
----------	-------	----	---------

## Exterior Varnish

Product	SKU	Description	Qty/box	MSRP
---------	-----	-------------	---------	------

### Exterior Varnish - Water-Based



PE700486	946ml Satin	6	\$39.75
PE700487	946ml Semi-gloss	6	\$39.75
PE700488	3.78L Satin	2	\$125.51
PE700489	3.78L Semi-gloss	2	\$125.51

## Surface Preparations And Cleaners

Product	SKU	Description	Qty/box	MSRP
---------	-----	-------------	---------	------

### Biodegradable Degreaser (TSP substitute)



	PE700350	500ml	12	\$7.15
--	----------	-------	----	--------

### Rust Remover and Lime Eliminator



	PE700400	946ml	6	\$14.37
--	----------	-------	---	---------

### Concrete Cleaner and Masonry Primer



	PE700403	3.78L	4	\$39.27
--	----------	-------	---	---------

### Degreaser



	PE700406	800ml	12	\$9.67
--	----------	-------	----	--------

### Adhesive Remover



	PE700409	500ml	12	\$15.42
--	----------	-------	----	---------

## Surface Preparations And Cleaners

Product	SKU	Description	Qty/box	MSRP
---------	-----	-------------	---------	------

### Grout Cleaner



	PE700412	946ml	6	\$11.79
--	----------	-------	---	---------

### Wood Floor Cleaner







	PE700415	800ml	12	\$12.47
--	----------	-------	----	---------

### Dry Time Extender for Water-Based Paint and Varnish



	PE700368	236ml	12	\$17.50
	PE700369	946 ml	12	\$31.55

## Inspiration

Product	SKU	Description	Qty/box	MSRP
<b>Poly/nylon Angular Brushes</b>				
	PE700500	37mm 1 1/2"	10	\$12.35
	PE700501	50mm 2"	10	\$16.17
	PE700502	63mm 2 1/2"	10	\$18.72
	PE700503	75mm 3"	10	\$21.03
<b>Staining Brush</b>				
	PE700505	Professional quality Removable handle - 100 x 25mm	8	\$23.25
<b>Single Lint Free Rollers</b>				
	PE700310	High density 10mm 3/8"	10	\$6.42
	PE700311	High density 15mm 1/2"	10	\$6.71
	PE700312	Super Smooth Finish MICROFIBER - 10mm 3/8"	10	\$7.38
<b>4" Foam Roller Kit</b>				
	PE700525	Including: - 2 rollers 100 x 10mm - Cage - Superior quality tray	20	\$10.02
<b>Foam Roller</b>				
	PE700513	<b>2 Pack Roller Refill</b> - 100 x 10mm	20	\$4.61



## Inspiration

Product	SKU	Description	Qty/box	MSRP
---------	-----	-------------	---------	------

### 4" Covered End Roller Kit

Improved product!



PE700524

Including:  
- 2 rollers 100 x 5mm  
- Cage  
- Superior quality tray

20

\$10.02

### Fabric Roller







PE700512

2 Pack Roller Refill - 100 x 5mm

20

\$4.61

## Performance

Product	SKU	Description	Qty/box	MSRP
<b>100% Nylon Angular Brushes</b>				
	PE700300	37mm 1 1/2"	10	\$8.77
	PE700301	50mm 2"	10	\$10.74
	PE700302	63mm 2 1/2"	10	\$12.47
	PE700303	75mm 3"	10	\$15.71
<b>100% Nylon Flat Brushes</b>				
	PE700307	50mm 2"	10	\$10.74
	PE700309	75mm 3"	10	\$16.63
<b>Staining Brushes</b>				
	PE700304	75mm 3"	15	\$8.67
	PE700305	100mm 4"	6	\$10.94
<b>Single Lint Free Rollers</b>				
	PE700315	Smooth Surfaces 10mm 3/8"	10	\$5.40
	PE700316	Smooth and Semi-Smooth Surfaces 13mm 1/2"	10	\$5.70
	PE700317	Smooth and Semi-Smooth Surfaces 15mm 1/2"	10	\$6.42
<b>Cage</b>				
	PE700320	No-Slip Professional Cage	20	\$7.38

## Performance

### Product Lint Free Roller Kit

Improved product!



SKU	Description	Qty/box	MSRP
PE700325	Including: - 2 rollers 100 x 10mm - Cage - Superior quality tray	10	\$9.95

### Lint Free Rollers

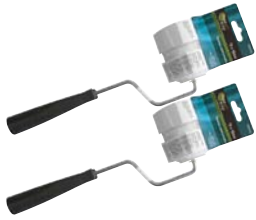

PE700336	Including: - Roller 75 x 5mm - Cage	20	\$3.75
----------	---	----	--------



PE700334	Including: - Roller 75 x 10mm - Cage	20	\$4.15
----------	--	----	--------

PE700337	Including: - Roller 100 x 5mm - Cage	20	\$4.51
----------	--	----	--------

PE700335	Including: - Roller 100 x 10mm - Cage	20	\$5.46
----------	---	----	--------



PE700338	<b>2 Pack Roller Refill - 75 x 5mm</b>	20	\$3.31
----------	--	----	--------

PE700339	<b>2 Pack Roller Refill - 75 x 10mm</b>	20	\$3.79
----------	---	----	--------

PE700332	<b>2 Pack Roller Refill - 100 x 5mm</b>	20	\$3.79
----------	---	----	--------

PE700333	<b>2 Pack Roller Refill - 100 x 10mm</b>	10	\$4.15
----------	--	----	--------

New!

### Essential



PE700103	<b>Angular Polyester Brush 63mm</b>	6	4,99 \$
----------	-------------------------------------	---	---------



PE700111	<b>3 Pack Roller Refill - 240mm x 10mm</b>	10	5,68 \$
----------	--	----	---------

## Performance

Product	SKU	Description	Qty/box	MSRP
---------	-----	-------------	---------	------

### Paint Pail



PE700345	-946ml Capacity -Adjustable hand strap -Brush Magnet	12	\$12.21
----------	--	----	---------



PE700346	-946ml Liner - For the PE700345	24	\$5.94
----------	------------------------------------	----	--------

### Drop Cloth

Improved!



PE700340	4' x 12'	4	\$17.93
PE700341	8' x 12'	4	\$42.88
PE700342	14' x 12'	3	\$66.98

### Cleaning Cloths



PE700130	White T-Shirt- 10lb	1	\$36.90
----------	---------------------	---	---------

### Sanding Sponge



PE700343	5" x 3" x 1" Large Size High Quality Angular Sanding Sponge Medium / Fine	12	\$3.63
----------	--	----	--------

## Essential

Product	SKU	Description	Qty/box	MSRP
<b>100% Polyester Angular Brushes</b>				
	PE700100	37mm 1 1/2"	16	\$6.34
	PE700101	50mm 2"	12	\$7.50
	PE700102	63mm 2 1/2"	12	\$8.77

## 5 Piece Roller Kit



PE700120	Including: - 100% Polyester Angular Brush 50mm 2" - Lint Free Roller - 10mm 3/8" - Cage - Tray - Liner Paint Tray	10	\$18.80
----------	---	----	---------

## 3 Pack Rollers



PE700110	Lint Free - 10mm 3/8"	10	\$11.43
----------	-----------------------	----	---------

## Cleaning Cloths



PE700130	White T-Shirt- 10lb	1	\$36.90
PE700131	White Sweatshirt - 10lb	1	\$31.74

## Polyurethane Painter's Gloves



PE700140	Small	12	\$4.99
PE700141	Medium	12	\$4.99
PE700142	Large	12	\$4.99
PE700143	X-Large	12	\$4.99
PE700144	XX-Large	12	\$4.99

Product	SKU	Description	Qty/box	MSRP
---------	-----	-------------	---------	------

Painters Drop Cloth - Economy



PE700322	4' X 12'	30	\$15.22
PE700323	9' X 12'	18	\$29.37
PE700324	12' X 15'	12	\$52.30